

**2014-15**

***Boys/Girls Track & Field***

**Manual for  
Schools**



## Revision History

May 11 Pg. 2 T & C's revised Classification Cut-offs  
May 14 Pg. 7 T & C's revised Field Event times at State Final

# IHSA Track & Field Manual and Forms for Athletic Directors and Coaches

## Table of Contents

<p>Table of Contents/Important Dates .....1</p> <p><b>I. Terms and Conditions</b>.....2-15</p> <p><b>II. Playing Rules</b></p> <p style="padding-left: 20px;">a. School Cover Letter.....16-17</p> <p style="padding-left: 20px;">b. Steps to Keep Schools Eligible to Participate in the Track &amp; Field State Series .....18-19</p> <p style="padding-left: 20px;">c. Schools Center Login Instructions.....20-22</p> <p style="padding-left: 20px;">d. Checklist for Coaches.....23-25</p> <p style="padding-left: 20px;">e. Online List of Participants .....26-28</p> <p style="padding-left: 20px;">f. Prevention of Heat Illness Guidelines .....29</p> <p style="padding-left: 20px;">g. Lightning Safety Guidelines.....30</p> <p style="padding-left: 20px;">h. Return to Play Policy.....31</p> <p style="padding-left: 20px;">i. IHSA Protocol for Implementation of NFHS Sports Playing Rule for Concussions .....32</p> <p style="padding-left: 20px;">j. Pole Vault Pit Specifications.....33</p> <p style="padding-left: 20px;">k. Shot Put Sector Set-up.....34</p> <p style="padding-left: 20px;">l. Do What's Right! Sportsmanship Criteria.....35</p> <p style="padding-left: 20px;">m. School's Responsibilities Towards Hosting Officials .....36-37</p>	<p><b>II. Meet Managers Handbook</b></p> <p style="padding-left: 20px;">a. Sectional Track Meeting Agenda .....38-39</p> <p><b>III. State Final Information</b></p> <p style="padding-left: 20px;">a. Eastern Illinois Stadium Diagram .....40</p> <p style="padding-left: 20px;">b. Eastern Illinois Campus Map .....41</p> <p><b>IV. Forms</b></p> <p style="padding-left: 20px;">a. Pole Vault Entry Card .....42</p> <p style="padding-left: 20px;">b. Official Competitor Scratch Verification Report.....42</p> <p style="padding-left: 20px;">c. Duplicate Awards Order Form (for additional, lost medallions, plaques, trophies for Dual Campus or Coop Schools) .....43-44</p>
--	---

## Important Dates To Remember

<b>2015 IMPORTANT DATES/DEADLINES FOR GIRLS AND BOYS TRACK &amp; FIELD:</b>	
Online Rules Meeting Presentation begins (Tue.)/RM Bulletin Posted	12/2
Season begins (Mon.)	1/19
1st Contest (Mon.)	2/2
Last Date of Online Rules Meeting Presentation (Mon.)	3/3
Vol. Official Deadline (Mon.) - Contact IHSA	3/30
Girls Online List of Participants (Mon.) – Noon	5/11
Girls Sectional Seeding Mtg. (Tue.)	5/12
Girls Sectionals (Thurs. or Fri.-Mandatory)	5/14-5/15
Girls State Final (Thurs.-Sat.)	5/21-5/23
Boys Online List of Participants (Mon.) – Noon	5/18
Boys Sectional Seeding Mtg. (Tue.)	5/19
Boys Sectionals (Thurs. or Fri.)	5/21-5/22
Boys State Final (Thurs.-Sat.)	5/28-5/30
Season Ends (Sat.)	5/30
T&F Advisory Meeting following the 14-15 season	9/9



# 2014-15 Boys and Girls Track And Field Series Terms and Conditions

In accordance with Section 1.450 of the IHSA Constitution, the Terms and Conditions governing the 2014-15 IHSA Boys and Girls Track and Field Meet Series have been approved by the Board of Directors.

## I. SCHOOL CLASSIFICATION

Competition in the IHSA Track & Field Tournament Series will be determined on an enrollment basis.

**A.** The classification of a school shall be determined on the basis of its total student enrollment figure reported to the Illinois State Board of Education in its Fall Housing Report on September 30 of the preceding school year. Non-boundaried schools will have their total student enrollment multiplied by 1.65.

**B.** For classification purposes, the total student enrollments for one-year high schools, two-year high schools, three-year high schools and high schools which enroll boys only or girls only shall be calculated as follows:

1. For one-year high schools, the total student enrollment figure reported shall be quadrupled.

2. For two-year high schools, the total student enrollment figure reported shall be doubled.

3. For three-year high schools, one-third of the total student enrollment figure shall be added to the total student enrollment figure reported.

4. For schools which enroll boys only or girls only, the total student enrollment figure reported shall be doubled.

**C.** A multiplier of 1.65 will be added to all non-boundaried schools.

**D.** Schools participating in Track & Field operating under the three-class system shall be classified as follows:

Girls & Boys Classification Cut-Offs:  
Class 1A: Up to 512; Class 2A 512.01-1382;  
Class 3A 1382.01 and over

**E.** Students with disabilities will compete in events within the Wheelchair Division regardless of school classification. A disability is a physical, visual or mental impairment which substantially limits one or more major life activity.

1. Wheelchair Division: students who use a wheelchair for mobility or sports or those that have been classified as T/F 31-34, T51-54, or T51-58.

Students who qualify for the Wheelchair Division will compete separately for place and medals, but events for this division can be held simultaneously.

Students with disabilities wishing to participate in this Division must have a statement of disability on file with appropriate personnel responsible for student health issues at the student's school. The IHSA reserves the right to request this documentation as part of the entry process.

## II. DATES AND SITES

**A.** The Girls Sectional meets will be held on THURSDAY, May 14 or FRIDAY, May 15. The IHSA T&F Administrator shall have the authority to schedule a sectional meet on Saturday when excessive travel is involved. There will be 14 sectionals in Class 1A; 11 sectionals in Class 2A and 11 sectionals in Class 3A.

**B.** The Boys Sectional meets will be held on THURSDAY, May 21 or FRIDAY, May 22. The IHSA T&F Administrator shall have the authority to schedule a sectional meet on Saturday when excessive travel is involved. There will be 14 sectionals in Class 1A, 11 sectionals in Class 2A and 11 sectionals in Class 3A.

**C.** The Girls State Final Meet will be held at Eastern Illinois University, Charleston, on Thursday, May 21 (Class 1A Prelims), Friday May 22 (Class 2A & 3A prelims), Saturday, May 23 (Class 1A-3A Finals).

**D.** The Boys State Final Meet will be held at Eastern Illinois University, Charleston, on Thursday, May 28 (Class 1A prelims), Friday, May 29 (Class 2A & 3A prelims) and Saturday, May 30 (Class 1A-3A Finals).

**E. Weather Conditions:** It is the responsibility of the local Sectional Manager and Meet Referee to make every effort to complete the Sectional meet on the date scheduled. It may become necessary to suspend an event or the meet due to severe storm or unusual weather conditions that cause competition to become hazardous. Since time is of the essence, suspended meets or events should be reconvened as soon as the safety of the competitors is assured. If after a reasonable delay, the Meet Referee and Manager must suspend further competition for that day, Friday night meets may be suspended until Saturday.

Sectional sites are selected on the basis of

their all-weather facilities and the capability of completing Sectional meets not later than Saturday if at all possible. Therefore, before a Meet Referee and Manager suspend a Sectional meet past Saturday, permission to do so must be secured from the administrator in the IHSA Office in charge of Boys and Girls Track and Field.

Assigned Sectional Meet Referees will be supplied a phone number to contact the IHSA Administrator closer to the event. It will be posted prior to the Sectional in the IHSA Officials Center in each Meet Referees personal site.

Suspended meets or events will continue from the point of interruption. The jumps, shot put or pole vault may be moved indoors, if facilities are available.

## III. ON-LINE ENTRIES, WITHDRAWAL PROCEDURES, ELIGIBILITY, AFFIRMATIVE ACTION, ON-LINE LIST OF PARTICIPANTS, ONLINE REQUIRED RULES MEETINGS

The policy for Original School Entry Deadlines, Late Entries, and Late Withdrawals shall be the policies and procedures regarding entry for all IHSA-sponsored sport/activities.

**Directions:** Login to the Schools Center (Official Representative or Principal Password is required to perform this task), Enter your School ID and Password, go to the activity tracker and click the button to add sports for the upcoming year. Spring Sports Entry Deadline is Feb. 1.

### A. On-Line School Entries

All member schools (including wheelchair track participants) must enter their school into the state series competition through the IHSA School Center on the IHSA Website at [www.ihsa.org](http://www.ihsa.org) to compete at the Sectional level in the Track and Field State Series. **Do not confuse On-Line School Entries with entering your School's "On-Line List of Participants."**(III-F) They are two different processes. On-Line School Entries are used to enter your school into the State Series Competition in order for the IHSA to assign your school to a Sectional Meet. The deadline for school entry is **February 1**.

**Six Contest Verification: (This for Schools entering a team. The six contest rule does not apply to schools competing as an individual or entries in the Wheelchair Division):** Information entered on-line will verify that the school's boys or girls interscholastic Track and Field team has

participated in six boys or girls interscholastic Track and Field meets during the current Boys and Girls Track and Field season and is thereby eligible to compete for team honors in the state meet series in accordance with IHSA By-law 3.054. Schools that have only individual(s) (not a team), or entries in the Wheelchair Division competing do not need to indicate they have competed in six contests in the List of Participants.

#### **B. Late On-Line School Entries:**

Any attempt to enter a sport or activity on-line after the established deadlines will be denied. Schools that wish to enter after the deadline will be considered a late entry. **To be considered** for late entry, the Principal/Official Representative must contact the IHSA administrative officer in charge of that sport or activity. The penalty for late entry shall be a payment of \$100.00 for that sport/activity by the school.

#### **C. Breach of Contract By-Law 6.041 (Withdrawal Procedure)**

To withdraw without penalty, the Principal must fax or email a letter to Tammy Craig at [tcraig@ihsa.org](mailto:tcraig@ihsa.org) at the IHSA Office, notifying IHSA of the school's withdrawal from Track and Field prior to the List of Participants deadline.

If a school withdraws after the List of Participants deadline and/or does not show up for competition, the school will be charged a \$100 penalty. If applicable, the school will be charged for any additional financial loss sustained by the offended school(s) or the Association as a result of such breach.

#### **D. Eligibility**

All member schools in good standing may enter an individual(s) or a team under the provisions of IHSA By-law 3.054.

In accordance with By-law 3.050, schools are subject to entering eligible student-athletes.

**E. Affirmative Action Policy:** Only boys may participate in the boy's competition in the state series and only girls may participate in the girl's competition in the state series, except as provided in the Illinois High School Association Affirmative Action Policy.

**F. On-Line List of Participants: Please review the instructions in the Manual for Schools for complete details.** Each school entering the state series (whether entering a team or individuals, or entries in the Wheelchair Division) must submit its On-line List of Participants via the Internet through the IHSA Schools Center Web Site to the IHSA Office. This List of Participants must be received in the IHSA Office by noon on Monday, May 11 (Girls) and by noon on Monday, May 18 (Boys). If a school does not submit the On-line List of Participants by the deadline, coaches and participants from that school are subject to sanctions, which could include but not be limited to being ruled

ineligible to compete in the State Series. Schools which do not submit their school's On-Line List of Participants and are consequently ruled ineligible from the State Series **must formally withdraw** (see Withdrawal Procedures/Breach of Contract above in section III-C). The On-Line List of Participants will provide space for each participating school to enter its athletes into each event and to list the accurate names of the Girls/Boys entered in the Sectional meet. No more than eight (8) Girls/Boys to be entered as runners or as alternates in the relays. **COACHES WILL ENTER THEIR INDIVIDUALS, RELAY TEAMS AND SEEDING TIMES ONLINE. SPACES LEFT BLANK WHILE COMPLETING THE ON-LINE LIST OF PARTICIPANTS MAY NOT BE FILLED IN AFTER THE ON-LINE LIST OF PARTICIPANTS ENTRY DEADLINE. IT IS RECOMMENDED TO PLACE AN ATHLETES NAME IN EACH BLANK. Coaches are encouraged to bring a hard copy of their On-Line List of Participants to the Sectional site the day of the seed meeting. This list must be printed prior to the On-line List of Participant deadline.** The option to print will not be available after that deadline. Refer to the School's Manual for complete instructions for completing the On-Line List of Participants.

Coaches may change or decrease the total number of **individual** entries submitted on-line at the sectional seeding meeting. Any changes must be made immediately upon arriving at the seeding meeting (before the results of the seeding are released to coaches). Any individual entry left blank during the on-line entry process **cannot be filled** at the sectional seeding meeting. **Times may be changed at the seeding meeting in any event.** No substitutions or changes shall be permitted in any events after the Sectional Seeding Meeting, except in individual events, in cases of a substitution made at the scratch meeting, prior to the start of the meet, made because of school disciplinary reasons, a death in the athlete's immediate family, or a disabling illness or injury to an entered contestant. Each substitute situation must be certified to by either the high school principal or attending physician to the Sectional manager. **NO CHANGES ARE ALLOWED TO YOUR LIST OF RELAY CONTESTANTS AFTER THE LIST OF PARTICIPANT DEADLINE HAS PASSED. REMEMBER, ONLY CHANGES TO TIMES AND INDIVIDUAL ENTRIES ARE ALLOWED AT THE SEEDING MEETING.**

This is probably the most important job as a coach to ensure your athletes are eligible to compete in the IHSA State Series. Please proof-read your work and double-check it. **Make sure you use all of the drop down boxes (8) when completing each relay.** We see time and time again, errors that can be avoided, if time is given to this process. (Athletes become ineligible because the coach didn't include them in the Online List of Participants). **After completing and certifying the Online List of Participants, print out a copy of the**

**completed List of Participants for your records (Ctrl+P keys on your computer keyboard). Take it to the seeding meeting. You will not have access to this page, if you try to print it after the deadline.**

**IMPORTANT: Make certain that it is clear if you are using F.A.T. times or manual times when completing your List of Participants. Manual times are given to the higher tenth (Example 10.42 manual must be entered as 10.5). To convert a manual time to F.A.T. , first round up to the higher tenth and then add .24 (Example 10.42 manual would be converted to F.A.T. as follows, 10.42 becomes 10.5, then add .24 = 10.74 converted). Do not enter manual times to the hundredth (round up to the higher tenth); doing so causes many problems for Sectional Managers as they seed their meet.**

Any track time recorded to the hundredth is assumed to be an FAT time. Therefore, ALWAYS list any manual time to the higher tenth (Example, a 10.42 manual time MUST be recorded as 10.5).

The IHSA Office will convert all times to F.A.T. prior to releasing entries to the Sectional Managers.

**Confirmation:** Coaches should login (using their User ID and password) to their School Center site on the IHSA website and select Activity Tracker. The Activity Tracker will indicate if this was completed. If the Tracker indicates not complete, then consider that an indication that the coach hasn't clicked on the last page of the form to Certify their List of Participants.

**IHSA will utilize the name spellings and year in school data from the On-Line List of Participants submitted by each school entered into the State Series for publication in the State Final Program.** If you notice an error after the on-line deadline, please email ([clowery@ihsa.org](mailto:clowery@ihsa.org)) or contact Cheryl Lowery at (309) 663-6377 at the IHSA Office.

No school shall enter competitors in a Sectional meet unless it intends for its qualifiers to participate in the State Final Meet if they qualify to advance.

**IMPORTANT NOTE TO SECTIONAL MANAGERS:** You must print relay heat sheets for each event for each school entered in your sectional from the computer program your meet utilizes. This is what your Clerk of the Course will use to determine if the runners that check in the day of the event are eligible to compete for each school. Without these printed lists, your clerk will not know who is eligible (as a result being included on the original List of Participants).

#### **G. COACHES' ATTENDANCE AT RULES INTERPRETATION MEETING**

The Track and Field On-Line Rules Interpretation Meeting is **REQUIRED** for **ALL** schools entering a team or an individual(s). Every **HEAD COACH** and all officials must view to receive credit for the 2014-15 Track and Field rules interpretation. To receive credit, the

HEAD coach/official must view the presentation in their respective IHSA School/Officials Center. While at times the on-line rules video may be accessible in other IHSA web locations, **the only site where a school or an official can receive credit is by logging in to their school/official center.**

#### **IMPORTANT NOTICE CONCERNING REQUIRED ON-LINE RULES MEETINGS:**

**It is important to make sure your Schools and Officials Center is up-to-date with contact information. Please double check:**

**Coaching & IHSA Member School Staff Compliance:** This IHSA Schools Center staff page is very important because if any information is missing from the coaching profile, the coach (head and/or assistant) will not be able to add his/her name to their list of coaches on their List of Participants and will not be issued credentials at the State Final. This page indicates:

- a. Who has been listed as coaches for your school (School Administrator only)
- b. How each coach on your staff is certified to coach (School Administrator only)
- c. If the coach has completed the PES Exam (one time requirement) (Coach)

**d. NEW STATE OF ILLINOIS REQUIREMENT): If the coach/athletic director has passed the Concussion Exam (every two years) (Coach/Athletic Director)**

(To make changes to this information, the School Administration should click on the "Staff Logins & Roster" link and click the name of the staff member needed to be edited and make necessary changes.)

**Coaches:** Login to the Schools Center to make sure you are listed as the coach for your school and your email address is current. If you are receiving emails and your school is not going to participate in the Track & Field State Series, this is a "Red Flag" that the IHSA believes that your school is entered and planning to participate. To avoid penalties, you must have your official representative withdraw your school by emailing tcraig@ihsa.org by the Online List of Participants deadline.

**Officials:** Login to the Officials Center to make sure your email address is current.

This information is required for IHSA to effectively communicate with its coaches and officials. If you are receiving notifications from our office, please do not ignore them. You are receiving communications because you are entered into the state series and we require/expect for you to meet all deadlines to remain eligible.

#### **Track and Field Online Rules Meeting Presentation Instructions**

Available December 2, 2014 through March 3, 2015.

Once the deadline passes your school will be placed on probationary status, if the online rules meeting presentation isn't reviewed by your coach. For probationary status to be lifted from your school you must:

Submit a \$50.00 penalty fee to the IHSA Office (you must contact Tammy Craig or Brandi Waters to process Visa, MasterCard or Discover credit card payments or school checks payable to the IHSA will be acceptable forms of payment). Upon receipt of payment, the schools center will be re-opened for your coach to view the online presentation.

**1) Go to [www.ihsa.org](http://www.ihsa.org)**  
**2) Click on "Schools & Officials Center"**

**3) Enter the Coaches "User ID" and the Coaches password**

**4) In the Activity Tracker, Click on "Rules Video" to begin presentation**

**5) View the online Rules Meeting and get credit by following the instructions in the presentation.**

**6) If you exit the video presentation prior to being instructed to do so, you will not receive credit and must watch the video again.**

**7) If you experience trouble getting credit for the Rules Meeting after you have viewed the complete presentation, please contact Cheryl Lowery at the IHSA Office to verify and issue a manual credit for the Rules Meeting.**

**NOTICE: If you are a coach at two different schools or you are a coach and also an official, you must contact or email Cheryl Lowery (clowery@ihsa.org) at the IHSA Office. She will give you dual credit. You must be listed as the coach at both schools in the respective Schools Center for the schools you are coaching for in order to receive dual credit.**

#### **Rules Meeting Presentation Troubleshooting (once you have tried and have failed).**

a. Try again on a different computer, preferably in a different location (home instead of school, etc.) Sometimes these files download badly. Going to a different computer/location is the easiest way to get a fresh start.

b. Go back to where you clicked on the link to start the presentation, and **INSTEAD** click on the link below to view the LITE version, which has no video content. Flash video can be an issue for some computers, and the lite version takes this out of the equation.

c. Individuals cannot watch the video on an iPad/tablet, and receive credit.

**d. You must click/watch every page to advance the presentation to get credit.**

e. If you experience trouble getting credit for the Rules Meeting after you have viewed the complete presentation, please

**contact Cheryl Lowery via email [clowery@ihsa.org](mailto:clowery@ihsa.org) or call the IHSA Office to verify and issue a manual credit for the Rules Meeting.**

#### **IV. HOST FINANCIAL ARRANGEMENTS**

**A.** Host school shall pay for all local expenses and issue checks to meet officials. Each host school shall receive a guarantee of \$900 and must submit results via internet to the IHSA Office. The host school shall be reimbursed the cost of officials (upon receipt of the Financial Report in the IHSA Office). The host school shall retain 20% of the net income and submit remainder to the IHSA. In the event of a negative balance, the host shall be reimbursed for the entire deficit. If admission is not charged, the host school shall forfeit the guarantee. In addition, Sectional meets shall abide by the IHSA Royalty Policy included in the current IHSA Official Handbook.

**B.** All Sectional meet expenses, including the meet officials' expenses in Item XI-A-1 will be paid by the host school. Host schools must either provide shells for the starter or make arrangements to pay them for their shells that they provides to start the sectional meet.

**C.** Neither the IHSA nor local meet management will assume responsibility for any other expenses of any kind for any meet except those expenses specified above.

#### **D. Admission Prices:**

1) At Sectional meets admission shall be: \$5.00.

2) At the State Final meet, admission shall be: Single session-\$10.00; Season-\$30.00.

**E.** The Sectional meet revenue shall include the television and radio rights fees collected by the Sectional manager as provided for in Item IX-F.

#### **F. Rights Fees for TV and Radio:**

1) Television Rights Fees to be charged by Local Managers and/or the IHSA are contained in the IHSA Television Policy.

2) Radio Fees which shall be charged are:

a) Sectional = No Charge

b) State Final = \$50.00

3) Policies regarding royalty requirements for each Local Manager are contained in the current edition of the IHSA Official Handbook. (See policies 31.)

#### **V. TOURNAMENT ASSIGNMENTS AND SEEDING MEETINGS**

**A.** About February 2, sectional assignments for schools that submitted an On-Line school entry on or before the February 1

deadline will be posted on the IHSA Web Site at [www.ihsa.org](http://www.ihsa.org) on the respective sport page under State Series Information and Results. Also the Manual for Schools and Managers outlining the State Track and Field meet series will be posted on-line at the IHSA T&F site; click on "Sports & Activities"; Click on Girls or Boys Track and Field; Click on Manual for Schools. The manual will serve as a guide for coaches and sectional managers during this Track & Field Sport Season. All schools entered in the IHSA Boys and/or Girls State Track and Field Meet Series will be assigned to their respective Class 1A, 2A or 3A Sectional meets on a geographical basis. Qualifiers from the Class 1A Sectional meets will participate in the Class 1A competition at the State Final meet. Qualifiers from the Class 2A Sectional meets will participate in Class 2A competition at the State Final meet. Qualifiers from the Class 3A Sectional meets will participate in Class 3A competition at the State Final meet. **This information can be found by clicking on the State Series Information and results link on the Track & Field page (upper left hand column).**

**B. Sectional Seeding Meeting:** All Seeding Meetings shall be held at each Sectional center on **Tuesday** prior to the Sectional Meet.

1) The Sectional Seeding Meeting shall not be held during the regular school day.

2) **It IS NOT mandatory for the head coach (or another school representative) to attend the Sectional Seeding Meeting. However, all schools are encouraged to send a representative to their respective seeding meeting. If a head coach (or another school representative) is not in attendance at the seeding meeting, those athletes must be FAIRLY SEED in spite of their coaches absence from the seed meeting. Any coach that chooses not to attend should send documentation of the times and trials submitted online for seeding to the sectional host. This information will become critical in the event the coaches in attendance challenge any time or trial submitted. Without such documentation, or knowledge by the coaches present, the time or trial may be rejected and the athlete seeded last, with a "no time" entry.**

3) Calling the Sectional Host and indicating that your school will not attend the seed meeting is greatly appreciated by Sectional Managers.

4) It is the responsibility of the Head Coach to contact the Sectional Host immediately if for any reason they experience an emergency situation that would not allow them to get to the seeding meeting on time (flat tire, traffic accident, etc.). Sectional managers will provide participating coaches with a phone number to be used in case of such emergency. **IF YOU DO NOT RECEIVE A PHONE NUMBER THEN YOU SHOULD ASK FOR ONE.**

**C. Items to be considered at the Sectional Seeding Meeting are as follows:**

1) Heats and sections shall be assigned for the track events and flights for the field events. The Sectional Manager shall provide each coach attending the Sectional Seeding Meeting with a printed copy of the heats, sections and flights before concluding the Sectional Seeding Meeting. Seed only the participants listed in the official IHSA List of Participants as retrieved from the Host School's IHSA School Center.

2) The supported computer software to manage and score sectional track and field meets is the Hy-Tek Meet Manager Software.

3) Times submitted for seeding purposes in all individual track events at the Sectional Seeding Meeting shall be times actually achieved at metric distances **during the current IHSA Track and Field season.** In a relay event, only a time actually achieved at the metric distance **during the current IHSA Track and Field season** may be submitted for seeding purposes. Coaches may not submit combined individual times as a relay time.

4) Marks submitted for seeding purposes in the field events at the Sectional Seeding meeting shall be English distance marks actually achieved during the current IHSA Track and Field season.

5) Indoor results from the same IHSA T&F season may be used for seeding purposes at the sectional meet.

6) If a boy/girl is entered in an excessive number of events at the Sectional seeding meeting, the local manager shall scratch the entries on the basis of the highest number as listed in the Table seen below. For example: If a girl/boy is entered at the seeding meeting in events No. 4 (3200-M. Run), No. 8 (800-M. Run), No. 16 (200 Meter Dash), No. 9 (Long Jump) and No. 18 (Triple Jump), the highest numbered event is No. 18; therefore, the competitor would be scratched from that event since the competitor is allowed to enter four (4) events at the seeding meeting.

Event Number	Event
1	4 X 800 Meter Relay
2	4 X 100 Meter Relay
3	Discus Throw
4	3200 Meter Run
5	100/110 Meter Hurdles
6	High Jump
7	100 Meter Dash
8	800 Meter Run
9	Long Jump
10	4 X 200 Meter Relay
11	400 Meter Dash
12	Pole Vault
13	300 Meter Hurdles
14	1600 Meter Run
15	Shot Put
16	200 Meter Dash
17	4 X 400 Meter Relay
18	Triple Jump

7) Schools are required to submit the On-Line List of Participants in advance of the Sectional Seeding Meeting. Coaches **may not for any reason** change the names in relays that were submitted by the deadline. They may make a change in the relay time originally submitted online. Coaches **may make** changes to their names **and** times in **individual events.** The final and official seeding into heats and sections for the track events and into flights for the field events will be completed at the Sectional Seeding Meeting with coaches present, **AFTER** all allowable changes to the original entries have been made.

8) **An individual entry left blank during the on-line entry process can not be filled at the sectional seeding meeting.**

9) **Any allowable changes or substitutions must be presented by the coach immediately upon arriving at the seeding meeting, and prior to the release of the final heat sheets to the coaches in attendance. Attempting to make changes or substitutions after viewing the heat sheets is not allowed (except to satisfy 15a through 15e below).**

10) Coaches may change or decrease the total number of individual entries submitted on-line at the beginning of a sectional seeding meeting.

11) At the Sectional Seeding Meeting, coaches in attendance shall elect, from among the coaches present, a Sectional Representative who will be responsible to submit a written report of coaches' suggestions to the IHSA Office not later than June 15.

12) If any question should arise on the legality of an entry under existing rules at the Sectional meet, the Sectional Games Committee must render a decision (no IHSA rules may be set-aside or ignored).

13) Participants will be assigned to heats/sections and flights in the track and field events on the basis of: (1) best times and marks; and, (2) the composite opinion of the coaches present at the meeting. If there is a discrepancy, (2) is to take precedence over (1). **Coaches must be able to verify times and marks submitted for Sectional seeding purposes in any given event if requested to do so by the Sectional Manager, Referee or by the coaches in attendance at the Sectional Seeding Meeting.**

14) Sectional Games Committee will be responsible for making the decision whether or not reseeding at the scratch meeting is needed, due to scratches. After the Scratch Meeting, only the Clerk of the Course and the Meet Referee may reseed if they deem it necessary.

15) **No substitutions shall be permitted in any event after the Sectional Seeding Meeting, except in cases of a substitution made (in an individual event only) because of school disciplinary reasons, or a death in the athletes immediate family, or a disabling illness or injury to an entered contestant which must be certified to by either**

the high school principal, Official IHSA Representative or attending physician (or the school's certified trainer) to the Sectional manager. **This substitution option does not apply to relay runners, nor does it apply after the meet has started.** Relay lists may not be changed after the noon deadline for any reason; therefore, coaches are encouraged to list eight names at the time of completing their online entries.

**Note:** In accordance with the Track and Field Rules, a school may scratch competitors from individual events to make them eligible to run on relay teams. HOWEVER, such scratches should be made before the Sectional meet begins.

#### **THESE RULES MUST BE FOLLOWED WHEN REPLACING AN INJURED ATHLETE**

a) Any allowable substitutions must be made just prior to the Sectional meet at a scratch meeting held for that purpose.

b) An athlete already entered in 4 individual events may not be used as a substitute for an injured athlete.

c) The substitute shall replace the contestant in the heat/section and lane assignment determined at the Sectional Seeding Meeting and the event shall not be reseeded only to accommodate the substitute.

d) The injured contestant being replaced (substituted for) shall not compete in any other events in the Sectional meet.

e) No such substitutions are allowed after the meet starts.

16) Sectional managers should adhere to a reasonable time schedule.

17) The decision(s) of the Meet Referee and Jury of Appeals shall be final in matters pertaining to the National Federation Track and Field Rules. Neither the IHSA Office nor the Board of Directors will review Meet Referee and Jury of Appeals decisions whether alleged errors are due to faulty judgment or misinterpretation of the rules (unless the Jury of Appeals has clearly exceeded its authority and elected to ignore rules).

18) All schools participating in the sectional meets are required to make available to the sectional host, one qualified volunteer to be assigned by the sectional host to work the meet. **This is mandatory beginning with the 09-10 State Series.** Adequate and competent help is critical to the success of all sectional T&F meets. Please help to ensure the success of your sectional meet by providing a qualified volunteer. **If the school fails to provide a quality volunteer, then a coach from that school's team must serve as a volunteer.** This will be true even if the school only has one coach, so head coaches are encouraged to get involved with their athletic director to ensure that this obligation has been met.

19) Sectional hosts are highly encouraged to have the appropriate device to check the size of each competitor's shot during the implement inspection process. In recent

years many competitors have been disappointed to discover at the state meet that their implement does not meet the NFHS size requirement and is not legal.

## **VI. TOURNAMENT STRUCTURE AND TIME SCHEDULES**

### **A. TIMING SYSTEM REQUIREMENTS**

• F.A.T. must be used for all running events at all sectional meets.

• If the IHSA T&F administrator has no option but to conduct any sectional meet at a site that does not have access to a F.A.T., then only the first and second place finishers in all running events in Track & Field and the Wheelchair Division will be allowed to advance to the state finals from that meet. No one will advance to the state finals by way of meeting the adopted qualifying standard on the basis of a manual time. The IHSA T&F Administrator will make every effort to identify a sectional host that will use an F.A.T. system. Decisions related to a failure of an F.A.T. system during the course of a sectional meet will be made by the IHSA Track and Field Administrator on a case by case basis. Consideration to any F.A.T. failure could only be considered if there were official back up times available from meet management. Without such back up times to consider only the top two finishers will advance from that event to the State Meet.

• A simple definition of an F.A.T. system is a one used to place and time the runners in any race which starts and stops automatically. Any timing system that requires an individual to start the system manually and/or others to stop the system, no matter how sophisticated is not a F.A.T. system.

• All sectional hosts will be required to send the IHSA the electronic files containing the results of their meet at the conclusion of their meet.

**B. If at all possible,** in priority ranking, Sectional meets will be conducted: (1) On 400-Meter all-weather tracks; (2) On 400-Meter tracks. 8 lane tracks are preferred over 6 lane facilities. The use of Fully Automated Timing (F.A.T.) is required.

**C.** At all Sectional meets, English measurements shall be used in all field events.

**D. Sectional Seeding:** For the Sectional meets and the State Final meet, detailed information and instructions for assigning competitors to heats, sections and lanes in the track events and to flights in the field events, is included in the Online Seeding Instructions document located on the Track & Filed page along with the Terms and Conditions, and Manuals.

1) In seeding at the Sectional, Lane 4 will be the preferred lane on an eight-lane track (4,5,3,6,2,7,1,8) and Lane 3 will be the preferred lane on a six-lane track (3,4,2,5,1,6).

2) If athletes from the same school are seeded in the same heat, they will not be separated. To do so provides that school with a potential advantage. Athletes will compete in the heat where they are originally seeded.

**E. Serpentine:** At sectional meets where semifinals are conducted (100, 200, 100/110 high hurdles), all races will be seeded using the Serpentine method.

### **F. Order of Events-Sectional/State**

**Final:** The order of events for the Finals of the State Final meet will be followed in the finals of the Sectional meets. At all state series meets where competition in the Wheelchair Division will occur, the designated race in the Wheelchair Division will occur immediately before the same race in the athletes without disabilities race. In the Sectional semifinals, the semifinals schedule given below should be followed for those events in which semifinals are held. In the semifinals and finals at the Sectional meets, the field events shall begin 1/2 hour before the track events.

**Note:** In the lane races at the Sectional meet, the number of competitors advancing to the finals shall not exceed the number of lanes on the track.

### **Girls and Boys Sectional Semifinal Schedule**

The use of F.A.T. is required for all sectional meets. Only Sectional Meets using the required F.A.T. will be allowed to advance competitors to the State Meet based upon a time acquired in the sectional finals. If practical, Field Events-Preliminaries and Finals should be run consecutively. Competitors in the Wheelchair Division shall be integrated into the field event preliminaries with competitors without disabilities. The Triple Jump should follow the Long Jump as soon as one pit is available.

100-Meter Dash Semifinals

100-Meter High Hurdles Semifinals

200-Meter Dash Semifinals

3200-Meter Run (First Section, when two sections are needed)

(Note: If the 200-Meter Dash Semifinals are needed, a 20 minute break shall be taken before the start of the finals of the meet.)

### **Girls and Boys Sectional Finals Order of Events**

4 x 800-Meter Relay Finals

4 x 100-Meter Relay Finals

3200-Meter Run (Against Time) (Second Section)

100-Meter High Hurdles Finals

100 -Meter Wheelchair Division

100-Meter Dash Finals

800-Meter Wheelchair Division

800-Meter Run Finals



4 x 200-Meter Relay Finals  
 400-Meter Wheelchair Division  
 400-Meter Dash Finals  
 300-Meter Low Hurdles Finals  
 1600-Meter Run Finals  
 200-Meter Wheelchair Division  
 200-Meter Dash Finals  
 4 x 400-Meter Relay Finals

Wheelchair participants will compete at the sectional to which their school is assigned. At the meet director's discretion, if there are sufficient lanes the Wheelchair Division may be run as one consolidated heat. For 2014 the Wheelchair Division will have 100-Meter, 200-Meter, 400-Meter, 800-Meter track events and shot put and discus.

**IHSA State Final Time Schedule  
 Wednesday, May 20 (Girls), May 27 (Boys)**

**Practice Schedule: 4:00 p.m. – 7:00 p.m.**

Schools may use the track and field facilities at O'Brien Stadium for practice and warm-up. These practice sessions are not the responsibility of the IHSA or of EIU. Athletes and coaches use the facilities to practice at their own risk. Coaches will be responsible for the safety of their athletes/staff. Coaches must be aware of the weather and react according to IHSA severe weather safety guidelines. (If it roars, go indoors!).

**4:00 p.m. – 10:00 p.m.:** Dorm Registration and check in at Taylor Hall.

**4:00 – 7:00 p.m.:** Coaches may pick up school packets at the south ticket window on the west side of O'Brien Stadium (parking lot side of stadium)

**7:00 p.m.:** State Final Manager, Head Officials and Games Committee meeting in the Lantz Building Varsity Room.

**Thursday, May 21 (Girls), May 28 (Boys)  
 1A Semifinals**

**8:00 – 10:00 a.m.:** 1A Schools only, may use track and field facilities at O'Brien Stadium for practice and warm-up.

**8:00 a.m. – 6:00 p.m.:** Coaches may pick up school packets at the south ticket window on the west side of O'Brien Stadium (parking lot side of stadium).

**10:00 a.m.:** High Jump, Long Jump, Triple Jump to follow the Long Jump

**10:50 a.m.:** National Anthem

**11:00 a.m.:** 1A competition begins in all running events.

**11:00 a.m.:** Pole Vault, Shot Put, Discus to follow the Shot Put

**Class 1A Track Order of Events**

4 x 800-Meter Relay Semifinals  
 4 x 100-Meter Relay Semifinals  
 (15-Minute Warm Up On Hurdles)  
 100-Meter High Hurdle/110-Meter High Hurdle Semifinals  
 100-Meter Dash Semifinals

800-Meter Run Semifinals  
 4 x 200-Meter Relay Semifinals  
 400-Meter Dash Semifinals  
 300-Meter Low Hurdles Semifinals  
 1600-Meter Run Semifinals  
 200-Meter Dash Semifinals  
 4 x 400-Meter Relay Semifinals

**Practice Schedule: Following the 1A meet– 7:00 p.m.** Schools may use the track and field facilities at O'Brien Stadium for practice and warm-up. These practice sessions are not the responsibility of the IHSA or of EIU. Athletes and coaches use the facilities to practice at their own risk. Coaches will be responsible for the safety of their athletes/staff. Coaches must be aware of the weather and react according to IHSA severe weather safety guidelines. (If it roars, go indoors!).

**Friday, May 22 (Girls), May 29 (Boys)  
 2A, 3A Semifinals**

**7:00 a.m. – 8:30 a.m.:** 2A and 3A schools only, may use track and field facilities at O'Brien Stadium for practice and warm-up.

**8:00 a.m. – 1:00 p.m.:** Coaches may pick up school packets at the south ticket window on the west side of O'Brien Stadium (parking lot side of stadium). Unclaimed packets will be left at the southwest gate of O'Brien Stadium.

**8:50 a.m.:** National Anthem

**9:00 a.m.:** The semifinals will be run in two parts. Part 1 will be Class 2A events and Part 2 will be Class 3A events. Class 2A track and field events will begin at **9:00 a.m.** Class 3A track events will begin at approximately **12:45 p.m.**, or later in case of delays. Class 3A field events should refer to the complete schedule for approximate starting times. The schedule of field events indicates the approximate starting times to be used as a guide.

**Format for Girls/Boys field events:** The Pole Vault will utilize both runways for flights 1 and 2, Flight 3 will begin as soon as flight 1 is completed. Thirty minutes warm-up will be permitted prior to the start of each flight.

Both runways will be utilized in the Long Jump and Triple Jump for flights 1 and 2 with the 3rd and 4th flights following on the first available runway. The Triple Jump will follow the Long Jump. Both circles in the Shot Put and Discus will be used with flights 1 and 2 starting at the same time with the 3rd and 4th flight to follow on the first available ring.

In the Long and Triple Jump: The wind direction will determine the layout of the runways. When practical, competitors will jump with the wind.

The final designations for number of flights, runways and times will depend on the number of qualifiers. Coaches must be alert for the time schedule and flight assignments that will be included in their school packets.

If there are more than 9 qualifiers in a specific event within the Wheelchair Division, those students will compete in semifinals on Friday. Athletes in the Wheelchair Division competing in field events will be integrated into flights in Class 2A on Friday but will be placed within the Wheelchair Division for awards and advancement to the finals. Athletes competing in the Wheelchair Division in Track events will compete in heats immediately preceding the equivalent heat in either Class 2A or 3A on Friday. For example, a semifinal in the Wheelchair Division in the 100-Meter will be run immediately preceding the 100-Meter dash run in the 2A class.

**Class 2A Field Events**

**8:00 a.m.:** High Jump, Long Jump, Triple Jump to follow the Long Jump

**9:00 a.m.:** Pole Vault, Shot Put, Discus Throw to follow the Shot Put

**Class 2A Track Order of Events**

**(Class 2A semifinals in the Track events will begin at 9:00 a.m.)**

4 x 800-Meter Relay Semifinals  
 4 x 100-Meter Relay Semifinals  
 (15-Minute Warm Up On Hurdles)  
 100-Meter High Hurdle/110-Meter High Hurdle Semifinals  
 100-Meter Dash Semifinals, Wheelchair Division (if necessary)  
 100-Meter Dash Semifinals  
 800-Meter Dash Semifinals, Wheelchair Division (if necessary)  
 800-Meter Run Semifinals  
 4 x 200-Meter Relay Semifinals  
 400-Meter Dash Semifinals, Wheelchair Division (if necessary)  
 400-Meter Dash Semifinals  
 300-Meter Low Hurdles Semifinals  
 1600-Meter Run Semifinals  
 200-Meter Dash Semifinals, Wheelchair Division (if necessary)  
 200-Meter Dash Semifinals  
 4 x 400-Meter Relay Semifinals

**Class 3A Field Events**

**(Times Approximate – Be prepared to go early!)**

**12:00 p.m.:** Long Jump, High Jump, Triple Jump to follow the Long Jump

**12:30 p.m.:** Pole Vault

**1:05 a.m.:** Shot Put, Discus Throw to follow the Shot Put (approx.. 2:45 p.m.)

**Class 3A Track Order of Events**

**(Class 3A Semifinals in the Track events will begin at approximately 12:45 p.m.)**

4 x 800-Meter Relay Semifinals  
 4 x 100-Meter Relay Semifinals  
 (15-Minute Warm Up On Hurdles)  
 100-Meter High Hurdle/110-Meter High Hurdle Semifinals  
 100-Meter Dash Semifinals  
 800-Meter Run Semifinals  
 4 x 200-Meter Relay Semifinals  
 400-Meter Dash Semifinals

300-Meter Low Hurdles Semifinals  
1600-Meter Run Semifinals  
200-Meter Dash Semifinals  
4 x 400-Meter Relay Semifinals

**Note:** The times for the semifinals are approximate. The Games Committee will determine if and when a break may be taken if the events are running ahead of schedule.

**Practice Schedule: Following the 2A/3A meet– 7:00 p.m.** Schools may use the track and field facilities at O'Brien Stadium for practice and warm-up. These practice sessions are not the responsibility of the IHSA or of EIU. Athletes and coaches use the facilities to practice at their own risk. Coaches will be responsible for the safety of their athletes/staff. Coaches must be aware of the weather and react according to IHSA severe weather safety guidelines. (If it roars, go indoors!).

**Saturday, May 23 (Girls), May 30 (Boys)  
(Finals in all events)**

**7:00 a.m. – 8:45 a.m.:** The track is open for warm ups to all finalists.

**9:15 a.m.:** Parade of Competitors (followed by Competitor Oath and recognition of head officials, honorary referees and National Anthem)

If there are nine or fewer students qualifying from Sectionals for a specific event within the Wheelchair Division, then that event will take place on Saturday.

If entries require preliminaries for Athletes in the Wheelchair Division competing in field events, the athletes will be integrated into flights in Class 2A on Friday. Those that qualify for the finals will be placed within the Wheelchair Division for finals and awards on Saturday. Athletes competing in the Wheelchair Division in Track events will compete in heats immediately preceding the equivalent heat in Class 2A on Friday (if entries require preliminaries). Those that qualify for the finals will be placed within the Wheelchair Division for finals on Saturday in heats immediately preceding the events for athletes without disabilities. For 2014, the Wheelchair Division will have 100-meter, 200-meter, 400-meter, and 800-meter track events, and shot put and discus.

**Field Events Finals – 1A followed by 2A followed by 3A**

**1A**

**10:00 a.m.:** Pole Vault

**10:00 a.m.:** Shot Put

**10:00 a.m.:** Long Jump

**10:00 a.m.:** High Jump

Triple Jump – To follow the Long Jump

Discus – To follow the Shot Put

**2A (Approximate start times – be ready to go)**

**10:00 a.m.:** Pole Vault

**10:45 a.m.:** Shot Put

**10:00 a.m.:** Long Jump

**12:00 p.m.:** High Jump

Triple Jump – To follow the Long Jump

Discus – To follow the Shot Put

**3A (Approximate start times – be ready to go)**

**11:30 a.m.:** Shot Put

**11:00 a.m.:** Long Jump

**12:00 p.m.:** Pole Vault

**2:00 p.m.:** High Jump

Triple Jump – To follow the Long Jump

Discus – To follow the Shot Put

**Track Events**

**10:00 a.m.**

Class 1A 3200-Meter Run, Section No. 1

Class 2A 3200-Meter Run, Section No. 1

Class 3A 3200-Meter Run, Section No. 1

**11:00 a.m.**

Class 1A 4 x 800-Meter Relay

Class 2A 4 x 800-Meter Relay

Class 3A 4 x 800-Meter Relay

**11:40 a.m.**

Class 1A 4 x 100-Meter Relay

Class 2A 4 x 100-Meter Relay

Class 3A 4 x 100-Meter Relay

**12:10 p.m.**

Class 1A 3200-Meter Run, Section No. 2

Class 2A 3200-Meter Run, Section No. 2

Class 3A 3200-Meter Run, Section No. 2

**1:10 p.m.**

Class 1A 100-Meter High Hurdles/110-Meter High Hurdles

Class 2A 100-Meter High Hurdles/110-Meter High Hurdles

Class 3A 100-Meter High Hurdles/110-Meter High Hurdles

**1:35 p.m.**

Wheelchair Division - 100 Meter Dash

Class 1A 100-Meter Dash

Class 2A 100-Meter Dash

Class 3A 100-Meter Dash

**1:55 p.m.**

Wheelchair Division - 800 Meter Dash

Class 1A 800-Meter Run

Class 2A 800-Meter Run

Class 3A 800-Meter Run

**2:25 p.m.**

Class 1A 4 x 200-Meter Relay

Class 2A 4 x 200-Meter Relay

Class 3A 4 x 200-Meter Relay

**2:55 p.m.**

Wheelchair Division - 400 Meter Dash

Class 1A 400-Meter Dash

Class 2A 400-Meter Dash

Class 3A 400-Meter Dash

**3:15 p.m.**

Class 1A 300-Meter Low Hurdles

Class 2A 300-Meter Low Hurdles

Class 3A 300-Meter Low Hurdles

**3:35 p.m.**

Class 1A 1600-Meter Run

Class 2A 1600-Meter Run

Class 3A 1600-Meter Run

**4:05 p.m.**

Wheelchair Division - 200 Meter Dash

Class 1A 200-Meter Dash

Class 2A 200-Meter Dash

Class 3A 200-Meter Dash

**4:20 p.m.**

Class 1A 4 x 400-Meter Relay

Class 2A 4 x 400-Meter Relay

Class 3A 4 x 400-Meter Relay

**5:00 p.m.**

Awards

## **VII. ADVANCEMENT OF WINNERS**

**A.** First and second place winners in all events from each Sectional meet shall advance to the State Final Meet.

**B.** In addition, any individual or relay team who equals or surpasses the qualifying standard in the finals of their respective Sectional Meet, for the Class they represent, at any Sectional Meet using F.A.T., shall advance to the State Final Meet in their Class. Also, any athlete in the throws and/or horizontal jumps equals or surpasses the qualifying mark in the preliminaries shall advance to the State Final Meet.

If a new event is added in the state series, first and second place winners from each of the sectional meets shall advance to the State Final Meet.

**C. The 2015 F.A.T. qualifying standards are as follows: (The same as 2014)**

Event	Girls 1A	Girls 2A	Girls 3A
Long Jump	16-4	16-11	17-6
Pole Vault	9-3	9-9	10-6
High Jump	5-2	5-2	5-3
Shot Put	35-6	37-0	37-8
Triple Jump	33-8	34-8	35-8
Discus Throw	108-0	112-3	117-6
4x800 M. Relay	10:22.24	9:58.04	9:38.24
4x100 M. Relay	:51.94	:50.84	:49.44
3200 M. Run	12:12.24	11:40.04	11:16.04
100 M. High Hurdles	:16.64	:15.94	:15.34
100 M. Dash	:13.04	:12.74	:12.54
800 M. Run	2:26.64	2:23.34	2:19.74
4x200 M. Relay	1:50.34	1:48.04	1:45.74
400 M. Dash	1:02.04	:59.90	:59.44
300 M. Low Hurdles	:49.04	:47.84	:46.94
1600 M. Run	5:35.14	5:25.24	5:14.24
200 M. Dash	:27.04	:26.64	:25.94
4x400 M. Relay	4:14.34	4:10.04	4:04.24

Event	1A Boys	2A Boys	3A Boys
Long Jump	21-0	21-8	22-3
Pole Vault	13-0	13-6	13-9
High Jump	6-3	6-3	6-5
Shot Put	48-0	50-11	52-11
Triple Jump	42-3	43-10	44-10
Discus Throw	143-0	149-0	156-6
4x800 M. Relay	8:26.24	8:15.24	7:58.04
4x100 M. Relay	:44.54	:43.54	:42.64
3200 M. Run	10:04.00	9:49.24	9:29.04
110 M. High Hurdles	:15.54	:15.24	:14.74
100 M. Dash	:11.14	:11.04	:10.94
800 M. Run	2:01.24	1:59.04	1:57.24
4x200 M. Relay	1:33.74	1:31.74	1:29.64
400 M. Dash	:51.74	:50.84	:49.94
300 M. Int. Hurdles	:42.00	:40.44	:39.84
1600 M. Run	4:37.24	4:30.44	4:22.04
200 M. Dash	:22.94	:22.54	:22.24
4x400 M. Relay	3:31.74	3:27.44	3:23.74

**Athletes with Disabilities Wheelchair Track & Field Qualifying Standards:**

Event	Wheelchair Girls	Wheelchair Boys
Shot Put	4'	6'
Discus Throw	8'	15'
100 M. Dash	:45	:40
200 M. Dash	1:35	1:25
400 M. Dash	3:15	3:00
800 M. Run	6:30	6:00

Note: Field events are listed in English measurements.

**1. Qualifying standards Information:**

a) In track events only, the qualifying standard (recorded with an F.A.T. system) must be equaled or surpassed in the final races. Times recorded in preliminary or semifinal races may not be used to qualify for the State Final Meet. The use of an F.A.T. system is required in order to qualify from a Sectional Meet to the state Meet based upon time.

b) In Sectional meets preliminaries shall be held in the Long Jump, Triple Jump, Shot Put and Discus Throw. Nine (9) contestants plus ties for ninth shall advance to competition in the finals. Any competitor who equals or surpasses the above qualifying standards for their Class shall advance to the State Final in the Long Jump, Triple Jump, Shot Put and Discus Throw.

c) The High Jump and Pole Vault should be run as finals. The qualifying standard for the High Jump and Pole Vault must be a measured height unless the height achieved is considerably in excess of the qualifying standard.

d) The qualifying standards for the field events are English distances and heights.

**D. Sectional Meets:**

Divisions conducting the following events must conduct preliminaries and or semifinals; in the 100 and 200-Meter Dashes and the 110/100-High Hurdles (unless the number of entries is equal to or less than the number of lanes on the track). All heat winners will advance to the finals as well as the next fastest time until the finals heat is full. Heat winners will be awarded the preferred lanes in the final heat.

**E. Sectional Meets:**

Divisions conducting the following events will conduct them as finals at Sectional Meets: 4 x 800-Meter Relay, 4 x 100-Meter Relay, 3200-Meter Run, 800-Meter Run, 4 x 200-Meter Relay, 400-Meter Dash, 300-Meter Intermediate Hurdles, 1600-Meter Run, 4 x 400-Meter Relay.

The winners will be chosen on the basis of the best time made and only one set of medals and points will be awarded in each event.

**F. Sectional Meets:**

The local manager will determine the number of sections to be run by the number of entries.

**G. Sectional Meets:**

At all Sectional meets, preliminaries and finals in the Field Events should be run off consecutively, if practical.

**H. Sectional Pole Vault:**

It is preferred that the Pole Vault be conducted at the assigned sectional site at the time of the sectional meet. However, due to increasing difficulties in obtaining sectional sites capable of conducting Pole Vault, the Pole Vault may be conducted at a different location prior to the Sectional (preferably the day before the sectional meet). If this is necessary, all schools competing must be:

a) Notified of the new location and time of the event.

b) The event must be conducted at a time that would not prohibit the competitors from competing in any other event at the Sectional meet.

c) A licensed Track & Field Official must be present to officiate during the event (supplied by the Sectional Manager).

d) All competitors must have a Certified Coach (By-Law 2.070) accompanying them.

e) **Note:** During the regular season coaches will be required to complete the Pole Vault weight verification card at all meets. Athletes will not be required to weigh in at these regular season meets, but the coach must verify that the athlete has been weighed and is using a legal pole as determined by the weight of the vaulter. This card can be found online at IHSA.org. A weigh in will occur during the IHSA State Series, this will include all sectional meets.

f) In the case of inclement weather, the pole vault and high jump may be moved to an indoor location. This decision will be made by the Meet Referee.

g) Beginning in 2014-15, All schools conducting the pole vault must use the new pole vault box pad defined in NFHS Track and Field Rule 7-5-22. The pad must meet the ASTM Standard F2949.

**I. Sectional Meets:** Relay Races – It is the clerk's responsibility to verify that all relay participants are listed on each school's original on-line list of entries for that event. Copies of the relay lists of participants (including alternates) must be provided by the Sectional Meet Manager developed from the IHSA Official online entries.

**J. State Final Meet:** If a school has qualified a relay team for the State Final, the names of the eight (8) runners who are entered in the relay must appear on the On-Line List of Participants submitted to the Sectional Meet Manager and the IHSA Office.

If a school qualifies a relay team for the State Meet, the four (4) designated runners in the semis or finals must be from the eight (8) runners who were listed on the On-Line List of Participants submitted to the Clerk of Course at the Sectional meet.

**K. State Final Meet:** A competitor may participate only in those individual events in the State Final meet for which they have qualified in Sectional competition.

**L. State Final Meet:** In the track events, nine (9) competitors or teams will qualify for the finals to be run on Saturday except in the 800-Meter Run, 1600-Meter Run and 4 x 800-Meter Relay where 12 will qualify for the finals. The 3200-meter run will be run in sections on Saturday.

**M. State Final Seeding:** In seeding the semifinals in running events at the state final meet, the top qualifier in each event from the sectional will be placed in the last heat, and the other top qualifiers from the sectionals will be placed in the heats in front of the top qualifier, accordingly. Seeding for the final in each running event shall be as follows: 1) Heat winners, according to their times, 2) all other qualifiers, according to their times. Qualifiers from the same school in an event will not be separated.

#### **N. Qualifying For Finals at the State Meet**

At the state final, in the semifinals of all running events, (In both the Athletes Without Disabilities Division and the Wheelchair Division if needed) the winner of each heat advances to the finals, and the remaining qualifying positions will be filled on the basis of time.

**O. State Final Meet Ties:** In case of a tie in the semifinals of the 100-Meter Dash, 100 or 110-Meter High Hurdles, and the 200-Meter Dash that would qualify more than nine (9) competitors for the Finals; Rule 4-4-4 will be followed. The tying competitors shall compete again for the available lane(s).

In case of a tie in the semifinals of the 300-Meter Hurdles, 400-Meter Dash, 4x100-Meter Relay, 4x200-Meter Relay, and the 4x400-Meter Relay, that qualify more than nine (9) competitors or teams for the Final; two final sections shall be run and the final places will be determined on the basis of time. The runners or teams with the best qualifying times will be placed in the second section with at least three (3) runners or teams in the first section.

In case of a tie in the semifinals of the 800-Meter Run, 1600-Meter Run, and the 3200-Meter Relay that would qualify more than twelve (12) competitors or teams; all tying competitors or teams will be assigned to the final race. Positions of the tying competitors or teams will be drawn and assigned as indicated in the State Final Seeding.

**NOTE:** If competitors have identical times recorded to 1/100th of a second, then timing to 1/1000 of a second will be used to break all ties to determine advancement and to determine final places.

**P. State Final Meet:** In a relay event, no substitute is permissible after a false start. Alternates listed on the relay team card are not charged with participation in a relay event unless they actually become a competitor in the relay.

**Q. State Final Meet:** The Jury of Appeals, in conjunction with the Head Field Referee, Head Pole Vault and Head High Jump judges shall announce the starting heights in the High Jump and Pole Vault for the preliminaries Tuesday previous to the State Meet on the IHSA Web Site. Competitors will be permitted to warm up at a lower designated height, but this must be done before the time scheduled for the start of the event.

**R. State Final Meet:** The Jury of Appeals shall approve definite qualifying heights for the Pole Vault and High Jump and only those competitors who clear the qualifying height in the preliminaries shall compete in the finals. The qualifying height is subject to the number and strength of entries.

**S. State Final Meet:** In the Shot Put, Discus (in both the Athletes Without Disabilities Division and the Wheelchair Division), Long Jump and Triple Jump, twelve (12) competitors plus ties for twelfth place will advance from the Preliminaries to the Finals.

**T. State Final Meet:** In the Pole Vault and High Jump, a minimum of nine (9) competitors will advance from the Preliminaries to the Finals.

**U. State Final Meet:** In both the semifinals and finals in the throws and horizontal jumps, measurements shall be made after each trial.

In the Finals, in the throws and the horizontal jumps, a measurement and announcement will be made after each trial.

### **VIII. TOURNAMENT RULES**

**A.** The current edition of the National Federation Official Track and Field Rules will be followed insofar as those rules apply to the events in which there is competition, unless otherwise specifically indicated in these Terms and Conditions or in other IHSA documents.

**Note 1:** Starting Blocks: Blocks that are adaptable to the track surface without potential damage to the surface may be used by contestants; otherwise, starting blocks provided by the management must be used by the competitors.

**B.** In accordance with IHSA By-laws 2.020 and 2.070, all schools are required to have a qualified coach and/or faculty representative present at all times during a meet and be available for assignment as might be required by the local meet manager. If a school does not have a qualified coach and/or faculty representative present at the Sectional site or the State Final site during warm-ups or competition that school's competitors shall not be permitted to participate.

**Note:** Schools are reminded that only coaches and faculty representatives who meet the provisions of IHSA By-laws 2.020, 2.070-2.079 and who are listed on the school's "List of Participants" shall be permitted to serve in those capacities at the Sectional and State Final meets.

#### **C. Participation Limitations:**

1) As stated in IHSA By-law 5.152, an individual contestant shall be permitted to participate in a maximum of four (4) track and/or field events.

2) A contestant officially becomes a competitor when the competitor or the relay team of which he/she is a designated runner reports to the Clerk of Course or to the Judge for a field event.

a) The eight (8) runners listed for each respective relay obtained from the On-Line List of Participants by the Sectional Manager are the only eligible runners in the respective relay. There can be no change in the

names of runners in a respective relay after the On-Line List of Participants has been submitted (it is permissible to change any time, including a relay time, at the seeding meeting). The Sectional Manager will not make any changes in relay runners at the seeding meeting. Nor will there be any changes from the list of runners submitted on the On-Line List of Participants allowed at the State Final in the event the school's relay team advances from the sectional to the State Final.

b) At the Sectional seeding meeting, a school may change or scratch its entries in the individual events.

c) The Sectional Manager will submit the runner information for each qualifying relay to the IHSA Office electronically, in addition to all individual event qualifiers when completing the On-Line Sectional Qualifiers Data.

3) If an individual contestant exceeds participation limitations in the Sectional or State Final meet, he/she shall forfeit all individual and team points earned in any events in which they competed and in accordance with the rules, he/she shall be disqualified from further competition in the state series.

**D. Uniform:** Competitors shall wear school issued track and field uniforms that meet the IHSA interpretations that follow:

1) NFHS Rule 4-3-1 — One or two-piece bodysuits, similar in color can be worn. Only undergarments approved by the school and coach, similar in color can be worn. Stripes down the side of the uniform will not be an issue. Once a running event or a field event has begun, there can be no disqualification for improper uniform. Competitors must compete in a school issued uniform that complies with NFHS Rule 4-3-1. It is the responsibility of the meet referee, starter, clerk of the course, and/or the respective field event head judge to inspect competitor uniforms prior to the start of the race or field event. They are not to knowingly allow a competitor in an illegal uniform to participate in the race or field event. If a field event judge or clerk of the course is uncertain whether a uniform complies with NFHS Rule 4-3-1, the clerk of the course or judge shall obtain a ruling from the meet referee or starter before starting the event. Referee, Starters, Clerks of the Course, and field event judges must be aware that schools may have multiple uniforms that they issue to their athletes. Athletes from the same school may participate in the same event in different school issued uniforms. If a competitor changes from an inspected uniform to jersey, shorts, undergarment(s), and/or any other unapproved items, and competes in the meet in an illegal uniform, the athlete is disqualified from the event and the meet for unsportsmanlike conduct.

2) NFHS Rule 4-3-2: In relay races, the clerk of the course, referee or starter shall not disqualify a team if the uniform worn by all

runners is not identical. The color of the shorts for all relay runners and the color of the track jersey (singlet) for all relay runners must be similar. The printing, design and/or lettering on the track jersey (singlet) must be such that each relay runner's school can be easily identified, and that as a person views the four track jerseys (singlets) together they appear similar and the relay runner's team is easily identified. The rule for undergarments will be interpreted the same as for the uniform (i.e.; must be similar).

3) Contestants wearing jewelry will be permitted to compete. Narrow headbands to keep the hair from interfering with the contestant's vision will be permitted. Contestants with painted bodies or faces as well as costumes, adornment or items deemed unsafe will not be permitted to compete nor participate in awards ceremonies. Medical alerts must be worn so they are visible.

4) Watches may be worn by competitors during track and field competition.

**E. Field Events:** Local Managers shall not permit a contestant to participate after the event judge has declared an event closed. In the field events, trials must be taken in order listed. If accommodations must be made because of a conflict, the competitor must consult with the head event judge in advance of, not after, the listed order of participants.

If a conflict has forced a competitor to miss his/her scheduled trial(s) in the High Jump or Pole Vault, he/she shall be given an allowance not to exceed five minutes after competition has been completed for his/her flight at the last height attempted in his flight. If he/she reports after this five-minute period, he/she shall be considered as having passed that height. In all other field events, he/she shall have a five-minute allowance after the trials in his/her flight have been completed.

In the Pole Vault and High Jump the one minute allowance for a trial, as prescribed in the NFHS Rule Book will start when the crossbar has been properly positioned for each jump/vault. In the Long Jump, Shot Put, Triple Jump and Discus Throw, the one minute time allowance in the NFHS Rule Book for the trial will begin when their name is called for the trial. In the Long Jump, Shot Put, Triple Jump and Discus Throw, the judges shall measure and announce the distance after each successful throw in the preliminaries and finals.

\*In the Shot Put and Discus Throw a throwing sector of 34.92 degrees will be used.

**In the Wheelchair Division the following modifications will apply.**

Students will be allowed to compete in throwing events from their wheelchair or from a throwing-specific chair ("field chair"). The field chair must comply with the Track Chair Track and Field USA or the International Paralympic Committee rules, or must comply with the following standards:

The field chair sitting surface including the cushion must not exceed 75 cm in height

If the field chair has a holding bar, it must be fixed (no articulating joints)

No part of the field chair may be outside the circumference of the circle

For shot put and discus, the wheelchair or field chair must remain stationary during the competition. The athlete may have an individual hold the chair during the throw to prevent movement. The wheelchair or field chair may be anchored with straps to stakes in the ground. The stakes and straps may be in or outside the throwing circle. The athletes may use non-elastic straps to anchor them into the chair. Athletes may compete with one or both feet on or off the ground. If the athlete competes with a foot on the ground, the foot must be inside the circle and the athlete's buttocks may not rise off the seat of the chair until the implement leaves their hand.

The size and weight of the discus and shot for the Wheelchair Division shall be the same as used for all other female or male participants.

**F. Running Events:**

1) The 400-Meter Dash (in both the Able Bodied Division and the Wheelchair Division), 200-Meter Dash, 300 Hurdles 4 x 100-Meter Relay and the 4 x 200-Meter Relay shall be run in lanes all the way. The start will be from staggered positions figured for one, two and four turns, respectively.

2) In the 4 x 400-Meter Relay, the first runners shall start from positions staggered for three (3) turns and shall run the first leg in lanes. After the first baton exchange, the second runner will run one additional curve staying in his respective lane and may cut for the pole position provided he is one full running stride ahead (approximately 7 feet) as provided in Rule 5-13-2. The lanes for the remaining exchanges will be determined by the "off the curve" system mentioned in Rule 5-10-11.

3) The 800-Meter Run (in both the Athletes without Disabilities and the Wheelchair Division), 1600-Meter Run and 4 x 800-Meter Relay and the 3200 meter run will be run in alleys. In races run in alleys, seeding will be non-serpentine from the outside in.

4) In the 110-Meter High Hurdles and the 300-Meter Intermediate Hurdles, the space between each hurdle shall be as prescribed in Rule 5-3-8.

5) The 100-Meter Dash (in both the Athletes without Disabilities and the Wheelchair Division), and 100 and 110 Meter Hurdles will be run in straight lanes with the runner competing and finishing in the same lane they started in.

6) Athletes in the Wheelchair Division, must compete in a manually operated wheelchair and must propel themselves. Students may use a wheelchair, track (racing) chair, or field chair for competition. It is

recommended that athletes use a track (racing wheelchair) for racing events and a field chair for field events. If a track chair is used, it must meet the following specifications:

- A wheel chair has a maximum of four wheels.
- The diameter of the two largest wheels (including inflated tire) does not exceed 28 inches
- For a track chair, the third wheel's diameter does not exceed 20 inches (including inflated tire) and is not smaller than 10 inches. Only one push rim shall be attached to each large wheel.
- The chairs seat, including cushion, shall not exceed 25 inches in height.
- The athlete, when in a racing chair (on or off the track) shall wear an approved bicycle or wheelchair racing helmet.
- The hub of the wheelchair's front wheels must be completely behind the vertical plane of the starting line at the beginning of the race.
- If an unsafe situation or mechanical failure should occur during the race, a competitor may be assisted back into his/her chair by a bystander in order to continue racing, if requested by the athlete. No forward assistance or momentum should be provided.
- The finish is determined by the front wheels breaking the vertical plane of the finish line.
- If not specifically mentioned in this document the chair shall comply with Wheelchair Track & Field USA (WTFUSA) / International Paralympic Committee (IPC) rules.

#### **G. Reporting To Clerk of Course:** At the State Final Meet

1) All contestants in each running event shall report to the Clerk's Tent at the first call for that event. Hip numbers for the electronic timing system will be given to all competitors when they report. Race instructions shall be given to competitors in all heats after they have received their hip numbers.

2) A running event is considered closed when the Head Clerk has taken the final roll call in the Clerk's tent. Contestants must report to the tent upon hearing the first call. **There will be only a first call and a final call.** The final roll call will take place at or around the final call and after final instructions have been provided by the clerk's staff. Failure to be present for the final roll call will cause disqualification from that event. The Head Clerk, who will ultimately take the final roll call, will have the authority to determine disqualifications resulting from a late check-in. It is clearly the responsibility of the coach and athlete to report on time. This type of disqualification cannot be appealed.

3) The Assistant Referee/Conflicts (field events/running events) will have the responsibility to oversee these conflicts and will have the final authority on disqualifications

related to conflicts. These disqualifications cannot be appealed.

#### **H. Official Times at State Final Meet:**

1) The Official Times at the State Final meet shall be the F.A.T. (Fully Automatic Times) recorded in 1/100 seconds and if needed, any MT (Manual Times) will be recorded in 1/10 seconds after rounding up to the next highest (slowest) tenth of a second, as required in the Track and Field Rules. These Official Times will be used for advancement, seeding and placement in an event. If in the semifinals there is a tie for the last qualifying position(s) for advancement, F.A.T. times to 1/1000 and manual times to 1/100 will be used. For example, such times will be recorded as 11.24(6) and 11.24(7). These times will be officially recorded as 11.24. If F.A.T. times are not available for all heats or sections of a race, the Manual Times will be the Official Times used for advancement, seeding and placement in an event.

2) Place results by the finish judges will not become official until the F.A.T. picture of the race, if available, has been reviewed by designated officials immediately after each race.

**I. Games Committee:** A Sectional Games Committee must be appointed for each Sectional meet. The Sectional Games Committee shall be comprised of the Sectional manager and four (4) head coaches present at the Sectional Seeding meeting. The Sectional Games Committee shall render a decision on questions that might arise on the day of the Sectional meet regarding the legality of an entry under existing rules. In accordance with Rule 3-2-4, the Sectional Games Committee shall act as the final Jury of Appeals for all final appeals of officials' decisions. At the State Final Meet, the Jury of Appeals shall act in accordance to National Federation Rule 3-5.

**Note 1:** All appeals of officials' decisions shall be submitted in writing to the Jury of Appeals by the head coach within 30 minutes of posting the results of the event.

**Note 2:** In ruling on such final appeals of officials' decisions, the Jury of Appeals shall determine if a rule has been misapplied (judgment calls are not appealable). The Jury of appeals shall not set aside or waive the provisions of any Track and Field Rule or IHSA State Series Term and Condition.

**Note 3:** The decision(s) of the Meet Referee and Jury of Appeals shall be final in matters pertaining to the National Federation Track and Field Rules. Neither the IHSA Office nor the Board of Directors will review officials' or Jury of Appeals decisions whether alleged errors are due to faulty judgment or misinterpretation of the rules.

**Note 4:** No IHSA or NFHS rule may be set-aside or ignored by the Games Committee/Jury of Appeals.

**J. Conduct:** Unsportsmanlike conduct by coaches or contestants or the use of profane language by coaches or contestants will not be tolerated and shall be penalized under the provisions of IHSA By-laws 3.140, 6.011 and 6.012 and in accordance with the Track and Field Rules.

1) In accordance with the provisions of IHSA By-law 6.033 and the Track and Field Rules, the decisions of the Meet Referee and Games Committee shall be final.

#### **K. Scoring:**

1) Sectional Meets: In the Sectional meets; six (6) places will be counted in determining the winning team. First, second, third, fourth, fifth and sixth places will count 10, 8, 6, 4, 2 and 1 points, respectively. Points in the relay events will be scored the same as each of the individual events. **No team points will be awarded based upon the results of the Wheelchair Division.**

2) State Final Meet: In the State Final meet, nine (9) places will be counted in determining the team order. First, second, third, fourth, fifth, sixth, seventh, eighth and ninth places will count 10, 8, 7, 6, 5, 4, 3, 2 and 1 points, respectively. Points in the relay events will be scored the same as each of the individual events. **No team points will be awarded based upon the results of the Wheelchair Division, nor to schools entering only individuals in the Able Body Division. Team points will only be awarded to schools that are entered as a team that has competed a minimum of 6 times during the current season.**

3) **Scoring of Ties:** In the Sectional and State Final meets, after the tie breaking procedures have been applied, if individuals or relay teams are tied for any of the places for which points are scored, the points earned by the tied competitors or teams shall be split. Ties in the High Jump and Pole Vault shall be broken as provided in NFHS Rule 7-3-2-b. Ties in the Long Jump and Triple Jump shall be broken as provided in NFHS Rule 7-3-2-a. Ties in the Discus Throw and Shot Put shall be broken as provided for in NFHS Rule 6-3-2-a.. Also, ties for second place at sectional meets must be broken in order to determine who will advance to the State Meet.

**Note:** In the State Final meet, in breaking ties for the first eight places in the High Jump and Pole Vault, the provisions of NFHS Rule 7-3-2-b shall apply. However, if any ties are broken on the basis of the number of "misses", only those "misses" recorded during the finals shall be considered.

#### **L. State Final Records:**

1) Any records established in the State Final Meet will be considered as the Class 1A, 2A, 3A, Wheelchair Division and/or all-time state high school outdoor record for the event. Marks established in meets other than the State Final Meet will not be considered for approval as a class or state high school record.

2) Records established in the Pole Vault, High Jump, Shot Put, Triple Jump and Long Jump at the State Final Meet will also be recognized as state records in situations where any of these events are held indoors.

3) National Interscholastic Records must conform to the provisions outlined in Rule 10 of the current Track and Field Rules Book.

**Note:** The Metric Records in Boys and Girls began in the 1980 Boys State Final Track and Field Meet.

#### **M. Special State Final Meet Provisions:**

1) The Discus Throw and Shot Put will be from concrete surfaced rings. The High Jump, Pole Vault, Triple Jump and Long Jump areas are surfaced with all-weather material. The track is surfaced with all-weather material. The indoor facilities at Lantz Fieldhouse are surfaced with a "Mondo Super X" type substance. Contestants will be permitted to wear spikes no longer than one-quarter inch (1/4") or rubber-soled shoes.

2) Seeding for the High Jump for Saturdays State Finals will be achieved by using the finalists sectional performances (not by using the performances from the Thursday or Friday prelims).

3) **School Packets: State Final Qualifier Packet Pick-up Times:** IHSA Staff will be available during the following times for packet pick up. Class 2A and 3A teams who plan to attend the 1A state final must pick up their team packets (bib numbers are your only ticket for free access to O'Brien Stadium):

**Wednesday:** 4:00 p.m.—7:00 p.m. at the south ticket window on the west side of O'Brien Stadium

**Thursday:** 8:00 a.m.—6:00 p.m. at the south ticket window on the west side of O'Brien Stadium.

**Friday:** 7:00 a.m.—1:00 p.m. at the south ticket window on the west side of O'Brien Stadium. Unclaimed packets will be available at the north ticket window on the west side of O'Brien Stadium.

4) Relay Designation: The four (4) designated runners who will participate in the relay shall be designated when the relay team is called and reports to the Clerk of Course.

5) Thursday Practice and Warm-up at Eastern: Please refer to the State Final Instructions in the back of the School and Managers Manual for details. Schools shall observe any restricted areas that might already be prepared for use only during the State Final meet.

6) Awards Presentation: Immediately following the Finals in an event, competitors shall report to the award stand for the awards presentation in that event. Competitors also must be at the awards stand during this time for the Official Photograph of the event award winners.

## **N. Pole Vault Requirements**

### **1) Contestant Weigh-In**

a) **Sectional:** A weigh in will occur during the IHSA State Series, this will include all sectional meets. Each contestant in the pole vault shall be weighed on site in advance of the competition. Contestant shall weigh in wearing their school issued uniform, and any clothing in addition to the school issued uniform that will be worn while vaulting, i.e. shoes and helmet. The combined weight of the person, all clothing, shoes and helmet will be the "competitor's weight" used to determine compliance with NFHS Rule 7-5 inclusive. Competitors must be weighed in prior to the start of the event. The "competitor's weight" shall be listed on the flight card for pole vault. Judges shall check the manufacturer's pole rating with the "competitor's weight" prior to each vault.

b) **Pole Vault State Final:** Each contestant in the pole vault shall be weighed in advance of the competition in the prelims only. Contestants will not be weighed in on Saturday of the state finals. Contestant shall weigh in wearing their school issued uniform, and any clothing in addition to the school issued uniform that will be worn while vaulting i.e. shoes and helmet. The combined weight of the person, all clothing, shoes and helmet will be the "competitor's weight" used to determine compliance with NFHS Rule 7-5 inclusive. At the State Finals every pole vaulter will weigh in at the hospitality tent, located in the south east corner of O'Brien Field. The "competitor's weight" shall be listed on the flight card for pole vault. Judges shall check the manufacturer's pole rating with the "competitor's weight" prior to each vault.

### **2) Pole Vault Coaches Area**

a) **Sectional:** An area will be designated for pole vault coaches in close proximity to the event.

b) **State Final:** An area designated at the retaining fence on the east side of O'Brien Stadium near the respective landing pit(s) pole vault coaches competing in the respective flight/finals shall be designated at the retaining fence on the east side of the O'Brien Stadium near the respective landing pit(s).

**Note:** During the regular season coaches will be required to complete the Pole Vault weight verification card at all meets. Athletes will not be required to weigh in at these regular season meets, but the coach must verify that the athlete has been weighed and is using a legal pole as determined by the weight of the vaulter. This card can be found online at IHSA.org. A weigh in will occur during the IHSA State Series, this will include all sectional meets.

## **IX. TOURNAMENT POLICIES**

### **A. Passes for the State Final Meet:**

1) A contestant number will be issued to each competitor who qualifies for the State Final, and it will admit contestant to the facility.

2) Rules for Coaches Passes

a) Coach Names must be on the Staff Roster in their IHSA Schools Center

b) and Coaches must have a completed PES and Concussion Exam date listed in their IHSA Schools Center

c) and each school must indicate how each coach is certified to coach and select how they are certified to coach in each coaches IHSA Schools Center

**Note:** Only coaches who are listed on the On-line List of Participants will be issued a coaches pass according to this formula: 1-5 qualifiers, school receive two (2) coaches passes; 6-10 qualifiers, school receives three (3) coaches passes; 11-above qualifiers, school receives four (4) coaches passes.

3) A copy of the school's On-Line List of Participants must be submitted to the IHSA Office prior to the Sectional seeding meeting. No more than four (4) Coach Passes will be issued to any school.

### **B. Mechanical Noisemakers:**

All mechanical noisemaking devices shall be excluded from the facilities (this would include the vuvuzela, the horn common at World Cup soccer events).

### **C. Signs and Banners:**

1) The display of signs, banners, placards or similar items at IHSA state series events is permitted, provided:

a) They are in good taste and reflect good sportsmanship in their message and use;

b) They reflect identification and encouragement to participants and their school/community;

c) They are not displayed on the field of play or in a manner which interferes with competition;

d) They do not obstruct the view of participants or spectators; and,

e) They are not safety hazards.

### **D. Damage to Property and Equipment:**

If contestants or people from any school entered in a state series meet are found guilty of carelessness or maliciously breaking, damaging, or destroying property or equipment belonging to the host school, such school shall be held responsible for costs incurred in replacing or repairing such property or equipment.

### **E. State Final Practice:**

1) On **Wednesday afternoon, 1A competitors** will be permitted to warm-up on the track from **4:00 p.m. until 7:00 p.m.**, and between **8:00 a.m. and 10:00 a.m.**, on

**Thursday morning.** On **Thursday night** from approximately **5:00 p.m. until 7:00 p.m.** (approximately 30 minutes following the 1A meet), the track will be open for **2A and 3A competitors** for practice. On **Friday morning** the track will be open for **2A and 3A competitors** from **7:00 a.m. until 8:30 a.m.** On **Saturday morning** the track will be open from **7:00 a.m. until 8:45 a.m.** for warm ups. The track will be cleared after these special warm-up times. Contestants shall not use the space inside O'Brien Field for warm-up or practice on the days of the **State Final** except at the above designated times. The track will be cleared promptly at 7:00 p.m. on Wednesday and Thursday after all special warm-up times.

**NOTE:** Schools may use the track and field facilities at O'Brien Stadium for practice and warm-up. These practice sessions are not the responsibility of the IHSA or of EIU. Athletes and coaches use the facilities to practice at their own risk. **Coaches will be responsible for the safety of their athletes/staff.** Coaches must be aware of the weather and react according to IHSA severe weather safety guidelines. (If it roars, go indoors!).

2) Contestants warming up at other than the above times during the meet may use the southeast area behind the tennis courts and the area behind the East bleachers or Lantz Field house, but shall not use unauthorized or **off limits** areas.

3) **Field Event Warm-up:** The Head Judge in each field event will conduct a maximum 15-minute warm-up prior to the beginning of competition in each flight in the field events. Competitors who report promptly to the Head Judge may participate in this warm-up. Exception: The discus competition will be permitted a 20-minute warm-up period.

#### **F. Media Requirements:**

1) Provide Space: Space shall be set aside to provide for news media representatives covering the state series whether they are from newspapers, radio stations, over-the-air television stations and/or cable television stations.

2) Radio and TV Originators: It is the responsibility of the local Manager to accept applications, approve requests to originate, collect proper rights fees payments (where required) and make cancellation refunds for television and/or radio play-by-play originations, according to the IHSA Television and/or IHSA Radio Broadcast Policy.

a) Television Rights Fees for all levels of competition below the State Final level shall be paid to the host school and shall become part of the revenue to be shared by the member school(s) and the Association according to the financial terms stipulated in these Terms and Conditions.

b) Radio Broadcast Rights Fees are not required for any level of competition in this series below the State Final. Local Managers shall permit radio play-by-play originations of the competition.

c) Television and/or Radio Stations which do not apply in advance, or which do not pay required rights fees prior to the start of competition in each respective level in this state series shall not be given credentials nor allowed access to the facility to originate. Sponsors of the originations for television and radio shall be only those so stipulated in the respective IHSA Television and Broadcast policies.

3) All media requirements for the State Final meet shall be handled through the IHSA Office.

4) Local tournament managers shall be responsible for reporting state series information and results to the IHSA Office and the news media as stipulated in printed instructions received from the IHSA Office.

#### **G. Tobacco Products**

The use of tobacco or liquid nicotine products in any competition area, either during a practice or while a contest is in progress, or affiliated property of any IHSA state series contest by any coach, player, any other person connected with a team, or fan shall be prohibited. State series hosts are required to make all state series contest sites and any affiliated property, including parking lots, fan accommodation areas, and other school or event venue property, tobacco/liquid nicotine free zones on the date or dates of any IHSA event being held at the site.

#### **H. Use of Inhalers**

A student with asthma may possess and use his/her medication during an IHSA competition, while under the supervision of school personnel, provided the school meets the outlined procedures of self administration in the Illinois school code.

#### **I. Alcoholic Beverages and IHSA State Series**

The possession, distribution, sale and/or consumption of alcoholic beverages are prohibited at the site and on any affiliated property of any IHSA state series contest. State series hosts are required to make all state series contest sites and any affiliated property, including parking lots, fan accommodation areas, and other school or event venue property, alcohol free zones on the date or dates of any IHSA event being held at the site. Violation of this policy by an event host will subject the host to a penalty for violation of IHSA By-law 2.020. Such penalty may include but not necessarily be limited to prohibition against subsequent event hosting assignments. Violation of this policy by a non-hosting member school will subject the school

to penalty for violation of IHSA By-law 2.020. Patrons of any IHSA state series contest determined to be in violation of this policy will be removed from the premise, and law enforcement officials will be called as warranted. No ticket refunds will be granted in such cases.

#### **J. Prayer at IHSA State Series Contest:**

Prayer at an IHSA event that takes place over the public address system is not allowed.

### **X. AWARDS**

#### **A. Sectional**

1) **Individual:** At the Sectional meets, medals will be awarded to the first six (6) place winners in each individual event and relay event in both the Athletes without Disabilities Division and the Wheelchair Division.

2) **Team:** A plaque will be presented to the school winning the team championship at the Sectional meets.

3) **Duplicate Awards:** An order form for Duplicate Awards can be found in the Manual for Managers posted online through the IHSA Schools Center.

#### **B. State Final**

1) **Individual:** At the State Final meet, medallions will be awarded to the first nine (9) place winners in each individual event in both the Athletes without Disabilities and the Wheelchair Division and relay event. In case of ties, duplicate individual awards shall be presented.

a) State Final place winners are to appear at the awards stand and receive their medallions only in their school issued uniform or school issued warm-up suit.

b) In all events, in order to be eligible for awards, individuals are required to report (and compete) to their event finals at the scheduled time, unless specifically excused by the IHSA Assistant Executive Director responsible for Track and Field.

2) **Team:** Trophies will be presented to the first, second and third place teams at the State Final meet. Only schools entering a "Team" that has competed in a minimum of 6 contests will be awarded team points (no team points will be awarded to schools with only individual entries). Medallions will be presented to the State Final qualifiers from the first, second and third place teams. Eighteen (18) medallions will be provided to qualifying competitors, two (2) coaches, one (1) Superintendent, one (1) Principal and one (1) Athletic Director. In case of ties, duplicate team awards shall be presented. **Non-Competitor's medals are included with the competitors' medals at the time of the awards presentations. Administrator's medals will not be packaged in separate boxes as they were in the past. If you wish for your coaches**



**and administrators to receive a team medal, then do not give them away to someone else. All medals you have to disperse will be hanging from the trophy at the trophy presentation.**

a) State Final place winners are to appear at the awards stand and receive their medallions only in their school issued uniform or school issued warm-up suit.

3) **Duplicate Awards for schools who are part of a Coop or have lost medallions or want to order more medallions:** Please use the form in your Manual for Schools.

## XI. OFFICIALS

### A. Appointment and Fees

1) **Sectional:** A minimum of (2) officials will be assigned to each Sectional Meet by the IHSA Office (Meet Referee, Starter). A third official (Assistant Starter) will be assigned if available. The Meet Referee, Starter and Assistant Starter for each sectional shall receive the following fees: Meet Referee \$84.00, Starter \$84.00, Asst. Starter \$68.25. Host schools must either provide shells for the starter or make arrangements to pay him/her for the shells he/she provides to start the sectional meet.

2) **State Final Meet:** Five (5) officials will be assigned to the State Final Meet by the IHSA Office. The Field Referee, the Meet Referee, the Class 1A, 2A and 3A Starters for the State Final meet shall receive a flat fee of \$382.50. The Assistant Starter shall receive a flat fee of \$292.50.

a) **Mileage Reimbursement Policy:** At sectional and state final meets the IHSA appointed officials will be paid mileage from the IHSA Office upon receipt of a mileage voucher submitted by said officials to the IHSA Office within 30 days of the contest. The IHSA appointed officials will receive 30 cents per

mile for every mile over 70 miles for each round trip. Mileage vouchers can be printed from the IHSA Web Site through the IHSA Officials Center. The eligible officials are as follows: Sectional Meets-Referee, Starter and Assistant Starter. At the State Final meets-Meet Referee, Field Event Referee, Head Starters (3), Assistant Starter, Coordinator of Officials and Meet Manager. **Note:** Mileage is determined to and from the official's home to the site of the competition, unless prior approval has been given from the administrator in charge of the sport/activity.

b) **Mandatory Officials Meeting:** There will be a mandatory meeting for the Head State Finals Officials at 7:00 p.m. on Wednesday at the State Final site.

c) **Head Officials Housing:** The IHSA has a block of rooms set aside for the five (5) Head Officials (mentioned above) in the dorms. The IHSA Office will be direct billed from EIU Housing for rooms. Head officials who incur an overnight lodging expense to attend the mandatory officials meeting are entitled to up to three (3) nights of lodging. Head officials must notify Cheryl Lowery at the IHSA Office, upon receipt of their State Final Officials Contract whether or not they will require housing reservations.

3) **State Final Volunteer Officials:** Girls Meet dates: May 21-23; 2015 Boys Meet Dates: May 28-30.

**Volunteers who are IHSA licensed officials at the State Meets:** You must go online through the officials' center to indicating you want to volunteer, which day(s) and shirt size. You will not receive a form in the mail.

**Volunteers who are non-licensed officials at the State Meets:** All non-licensed officials who volunteered at last year's meet(s) will be sent an email in early January. If your email address has changed from last year, please notify Cheryl Lowery

clowery@ihsa.org of your new email address.

**People who have never volunteered at the State Track Meets:** If you would like to volunteer this year at either the girls or boys state final, a Volunteer Registration form is available through the IHSA Girls and Boys Track Webpages, download and complete the form and email or fax it to Cheryl Lowery ( clowery@ihsa.org).

4) **State Final Volunteer/Spectator Housing:** All persons who work the respective state final meets are responsible for their own housing. A listing of motels in the Charleston-Mattoon area can be found on the track and field page(s) in the IHSA Web Site at www.ihsa.org. In addition, Eastern Illinois University will make dormitory rooms available both weekends. Visit: www.eiu.edu/~ihsa or Call EIU Housing at (217) 581-3923.

a) **2015 Housing Costs – per person not per room (Tax included, Double room rates assume two people in the room):**

\$40.00 per person in a Double Room for 3 nights

\$30.00 per person in a Double Room for 2 nights

\$20.00 per person in a Double Room for 1 night

\$60.00 per person in a Single Room for 3 nights

\$45.00 per person in a Single Room for 2 nights

\$30.00 per person in a Single Room for 1 night

### b) **Housing Check In Location**

Team Check In: Lawson Hall  
Officials and Spectator Check-in: Stevenson Hall



## Track & Field Information



- [www.ihsa.org](http://www.ihsa.org) • [rmcgraw@ihsa.org](mailto:rmcgraw@ihsa.org) or [clowery@ihsa.org](mailto:clowery@ihsa.org)
- Phone: 309-663-6377 • Fax: 309-663-7479 •

Attention Schools entered in IHSA Track and Field State Series:

This manual should be used as a guide for your Track Coach and/or Athletic Director to inform them of required deadlines and procedures pertinent to Track & Field. Please review and/or distribute this manual to the proper person at your school who will be responsible for its administration.

It is important to make sure your IHSA Schools Center is up-to-date with coaches contact information. Please double check. Login to the Schools Center to make sure you are listed as the coach for your school and your email address is current. If you are receiving emails and your school is not going to participate in the Track & Field State Series, this is a “Red Flag” that the IHSA believes that your school is entered and planning to participate. To avoid penalties, you must have your official representative withdraw your school by emailing [tcraig@ihsa.org](mailto:tcraig@ihsa.org) by the Online List of Participants deadline.

**Staff Compliance:** Go to [www.ihsa.org](http://www.ihsa.org)

- 1) Click on IHSA Schools & Officials Center Login
- 2) Enter your User ID (5 digit ID, a letter followed by 4 letters) and Official Representative or Principal password
- 3) Click on Staff Compliance

**Why:** This page is very important because if any information is missing from the coaching profile, the coach will not be able to add his/her name to their list of coaches on their List of Participants and will not be issued credentials at the State Final. This page indicates:

- a. Who has been listed as coaches for your school (AD, Principal, Official Representative)
- b. How each coach on your staff is certified to coach-ie.: ISBE/ASEP/NFHS. (AD, Principal, Official Representative must complete this information).
- c. If the coach has completed the PES Exam (one time requirement)
- d. If the coach has passed the Concussion Exam (every two years)

(To make changes to this information you should click on the “Staff Logins & Roster” link and click the name of the person you want to edit and make necessary changes.)

Please be aware that in order to be listed as a coach all the above requirements must be accounted for in the job/coaching profile in the IHSA Schools Center. **If the name of your coach doesn't appear in the drop-down menu, it is an indication that all or part of their coaching requirement information is missing from their IHSA Schools Center. Until their coaching profile in the IHSA Schools Center is complete, their name will not appear and they are an ineligible coach (contact your Athletic Director, Officials Representative or Principal to update the information). Coaches will not receive coaching credentials during the state series unless their Schools Center coaching profile requirements have been completed.**

**Terms and Conditions:** The Terms and Conditions are located on the respective IHSA Track Web Page and in this manual. Please read them carefully. They are the rules governing the IHSA Girls and Boys Track and Field State Meet Series.

**Assignments:** Schools which have entered have been assigned to Sectional meets on the following geographical basis: (1) Distance from the center; and, (2) Location of schools willing and selected to host a Sectional meet. Schools may not participate in a Sectional meet other than the one to which they are assigned. The current Track & Field Assignments are posted under State Series Information and Results on the IHSA Web Site on the respective Girls and/or Boys Track & Field web pages.

**Online Rules Meeting Requirement:** All Head coaches of schools entered in Track & Field are required to view the online Rules Meeting Presentation, including schools only entering individuals.

**Hy-Tek Software Offer:** In an effort to standardize the entry process for IHSA Track and Field, the IHSA adopted Hy-Tek Track and Field software as the official software for managing our State Meets. This IHSA adoption in no way requires you to purchase Hy-Tek Track and Field software, however if you are purchasing meet management software for Track and Field, we highly recommend it. The ACTIVE Network will provide member schools with a 25% group discount (new purchases only) in the event that your school does wish to purchase Hy-Tek Track and Field software in the future. If you choose to make a purchase, contact Hy-Tek at their website @ hy-tekld.com.

This IHSA adoption in no way requires you to purchase Hy-Tek Track and Field software. However, we have been made aware by member schools that the majority of schools that currently own and use Track and Field software, already own the Hy-Tek product. Consequently, the IHSA has decided to purchase the software so that our online entry process for our State Series will be easier for our schools that host the Sectional Meets. By purchasing the Hy-Tek Meet Manager we hope to be capable of sharing the schools online entries with our Sectional Managers in a format that will not require them to be forced to manually reenter the schools individual entries. It is our sincere hope that our purchase of this product will make the management of our State Series meets easier for all involved.

**Track and Field Online List of Participants:** Complete instructions are included in this manual.

**Coaches Checklist:** A checklist for coaches is enclosed in this manual for use in completing those tasks through the Sectional level that are necessary on behalf of their student-athletes.

**Information about the Policies and Procedures for Seeding that will be followed for Sectionals is posted on the Girls and Boys Track & Field websites.**

**Sectional Meet Personnel:** The track & field terms and conditions require all schools entered in the state T&F series to provide one qualified individual to work at the schools assigned sectional meet. If your Sectional Manager assigns (or asks) your school to provide meet personnel, please carry out this responsibility on behalf of your school and the entire IHSA Track and Field State Series. We trust you will provide experienced and trained personnel who will perform their assigned duties in a fair and efficient manner at the Sectional meet. We trust that you will do everything you can to assist the Sectional Manager to conduct a successful meet. The Sectional Manager and the Illinois High School Association appreciates your cooperation and assistance in this important matter.

**Note:** Each principal/official representative is reminded that in accordance with the provisions of IHSA By-law 2.020 an accredited faculty representative must be appointed who will be present and responsible to her/him for the conduct of competitors and persons from her/his school at all times during their participation at the Sectional and/or State Final meets.

**State Final Volunteers:**

Non-licensed people interested in volunteering to work at the IHSA State Track & Field Championships should email [clowery@ihsa.org](mailto:clowery@ihsa.org)

Licensed officials should volunteer through their Officials Center.

The IHSA State Series in Track & Field has been a benchmark event for High School competition. That's what our State Final Meets have been over the years. With your help we will continue our great tradition!

Sincerely,

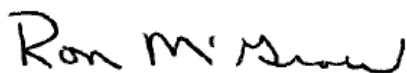

Ron McGraw  
Assistant Executive Director

# Steps to Enter and Participate in the Track & Field State Series

If you receive an email from the IHSA office, please do not ignore it. If you are not the person responsible, please forward the email immediately to the appropriate person for follow up with our office. This is a "Red Flag" that IHSA needs important information from your school. If you are not the person, contact the school to remove your email from their list of school personnel.

## A. What: Enter school into the Track & Field State Series

**Who:** Principal or Official Representative

**When:** By February 1

**Where:** IHSA.org

**How:** Go to [www.ihsa.org](http://www.ihsa.org)

- 1) Click on IHSA Schools & Officials Center Login
- 2) Enter your User ID (5 digit ID, a letter followed by 4 letters) and Official Representative or Principal password
- 3) Click on Sport & Activity Tracker
- 4) Click on "enter your programs"
- 5) Click all applicable sports your school will participate in for 2014-2015

**Why:** This data is what IHSA uses to assign schools to their Sectional sites.

## B. What: Staff Compliance in the IHSA Schools Center

**Who:** Principal, Official Representative, Athletic Director

**When:** By February 1

**Where:** IHSA.org

**How:** Go to [www.ihsa.org](http://www.ihsa.org)

- 1) Click on IHSA Schools & Officials Center Login
- 2) Enter your User ID (5 digit ID, a letter followed by 4 letters) and Official Representative or Principal password
- 3) Click on Staff Compliance

**Why:** This page is very important because if any information is missing from the coaching profile, the coach will not be able to add his/her name to their list of coaches on their List of Participants and will not be issued credentials at the State Final. This page indicates:

- a. Who has been listed as coaches for your school
- b. How each coach on your staff is certified to coach
- c. If the coach has completed the PES Exam (one time requirement)
- d. If the coach has passed the Concussion Exam (every two years)

(To make changes to this information you should click on the "Staff Logins & Roster" link and click the name of the person you want to edit and make necessary changes.)

## C. What: Review the Online Manual for Schools

**Who:** Coach and/or Athletic Director

**When:** Mid December

**Where:** The Manual for Schools **will be posted on the respective IHSA Track & Field Activity Page and in the Schools and Officials Center (by logging in):**

**How:** Go to [www.ihsa.org](http://www.ihsa.org)

- 1) Click on "Activity Tracker"
- 2) Click on Manual for Schools (If the Track & Field Manual for Schools doesn't appear, you are not listed as the coach and/or your school isn't entered to participate this year).

**Why:** This manual has information for coaches and athletic directors as to what is necessary in order for their athletes to participate in the Girls and/or Boys Track & Field State Series. Failure of coaches and athletic directors to become familiar with these details often results in the student athletes and/or coaches from their schools being denied the opportunity to compete.

- 4) In the Resource Section, Click on the "Manual for Schools".

**Why:** This is how the coaches and athletic directors learn what is necessary in order for their athletes to participate in the Girls and/or Boys Track & Field. Failure of coaches and athletic directors to become familiar with these details often results in the student athletes and/or coaches from their schools being denied the opportunity to compete.

## D. What: Online Rules Video Presentation for Girls and Boys Track & Field

**Who:** All schools entering Track & Field must have each **Head Coach** view the online rules video. **By-Law 2.120 requires schools entering a sport as teams or individuals must view the online rules video**

**When:** Available December 2 through March 3. A \$50.00 penalty will be assessed after the deadline and placed on probation the first year and/or suspended the second year for failure of redeeming credit for online rules video.

**How:** Go to [www.ihsa.org](http://www.ihsa.org)

- 1) Click on "School & Officials Center Login"
- 2) **Boys & Girls Head Coaches:** Enter your User ID (5 digit ID, a letter followed by 4 digits) and your boys or girls Track & Field Coaches password.
- 3) Click on "Rules Video" next to Girls or Boys Track & Field
- 4) View the online Rules Video to view, interact and receive credit.

**Why:** This is a yearly requirement for **EVERY HEAD BOYS AND GIRLS COACH** (TEAM & INDIVIDUAL ENTRIES)

## E. What: Entering Participants into the State Series Meets: "Online List of Participants"—Do not wait until the last minute, you can always make changes up until the deadline.

**Who:** Coach

**When:** Deadline is Noon, May 11 (Girls)/Noon, May 18 (Boys) - If a school does not submit their Online List of Participants by the deadline, coaches and/or participants from that school are subject to sanctions, which could include but not be limited to being ruled ineligible to compete in the State Series. Schools which do not do so and are consequently ruled ineligible for the State Final Series and must email [tcraig@ihsa.org](mailto:tcraig@ihsa.org) a letter indicating they are withdrawing from the Track & Field State Series by noon on the day of the Online List of Participants deadline or a \$100.00 penalty will be assessed to your school.

**Where:** Go to [www.ihsa.org](http://www.ihsa.org)

- 1) Click on "School & Officials Center Login"
- 2) Enter your "User ID" (5 digits, a letter followed by a number) and the password issued to you by your school. All of this information was emailed to you by your school. IHSA login ID and your unique Track & Field Coaches password (Boys and Girls Coaches have different passwords), issued through your school administration through the IHSA Schools Center.
- 3) Click on Sport & Activity Tracker
- 4) Click on the "List of Participants" link
- 5) Type in the requested information and save your page(s).
- 6) **Certify & Submit your Form**
- 7) **PRINT EACH PAGE (ctrl key+P) on your keyboard. After the deadline, you will not be able to do so.**

**Why:** This is how the IHSA knows the names of the participants and coaches. This information will later be used in the State Final Program. It will be used as it is presented so please double check spellings for accuracy.

**F. What: Withdrawal from Track & Field after being entered**

**Who:** Principal or Official Representative

**When:** Prior to Noon, May 11 (Girls)/Noon, May 18 (Boys)

**Where:** IHSA Office

**How:** Email Tammy Craig ([tcraig@ihsa.org](mailto:tcraig@ihsa.org)) a letter indicating the desire to officially withdraw.

**Why:** Schools that fail to participate after entering and who fail to formally withdraw will be fined \$100.00 (additional penalties may apply, refer to Terms and Conditions). The fine is necessary to encourage schools to make us aware of their intent not to participate. When schools do not show up it adversely affects the balance in the numbers of teams assigned to each Sectional. This can create situations that are unfair to others. When you become aware that your school will not participate in the State Series, please withdraw immediately!

**G. What: Wheelchair Track On-Line List of Participants**

**Who:** Coach/Athletic Director

**When:** Deadline is May 11 (Girls)/May 18 (Boys). If a school does not submit their On-Line List of Participants by the deadline, coaches and/or participants from that school are subject to sanctions, which could include but not be limited to being ruled ineligible to compete in the State Series and/or charged a \$100.00 penalty. Schools which do not do so and are consequently ruled ineligible for the State Final Series must formally withdraw (see Withdrawal Procedures/Breach of Contract section in the Track & Field Terms and Conditions).

**How:**

- 1) Go to [www.ihsa.org](http://www.ihsa.org)
- 2) Click on "Schools & Officials Center"
- 3) Enter "School ID" and either the Official Representative, Athletic Director or Spring Coaches "Password"
- 4) Click on "T" Sports and Activity Tracker; Click on "Girls or Boys Wheelchair Track & Field List of Participants"
- 5) Please review the procedures included in this manual

**Why:** This is how the IHSA knows the names of the participants and coaches. This information will later be used in the Online Sectional/State Final Results and the State Final Program. It will be used as it is presented so please double check spellings for accuracy.

**Reasons for the "Red Box" to appear in the Sport/Activity Tracker (If you meet any of the following criteria, you may disregard the "Red Box"):**

- Some schools will not have a competitor in every event offered.
- Schools entering as Individuals would not verify to have competed in at least 6 Contests (this is for schools entering as teams and have competed in 6 contests to be eligible for team honors).
- School hasn't "Certified & Submitted" their List of Participants.

**Verification of IHSA Receiving List of Participants:**

- Print a copy once you have completed the Sectional entries. This is your verification and if necessary, you can provide proof of your entries at the Sectional Seeding Meeting, in case of computer or file download error (very rare).
- Make sure you click on the "Certify & Submit" page so you will not receive unnecessary reminders from our office about not receiving your Track & Field List of Participants.

Once the process is complete and the deadline date approaches, the Schools Center Activity Tracker will show that the deadline has passed. This does not mean your school didn't complete it. It means the IHSA Office has imported all rosters and is in the process of preparing the files for the Sectional Managers.

After completing and submitting the Online List of Participants, print out a copy of the completed List of Participants for your records. You will not have access to this page, if you try to print it after the deadline.

**H. What: Withdrawal from the State Series after being entered by the Principal**

**Who:** Principal or Official Representative

**When:** Deadline is May 11 (Girls)/May 18 (Boys)

**How:** Email Tammy Craig ([tcraig@ihsa.org](mailto:tcraig@ihsa.org)) a letter indicating the desire to officially withdraw.

**Why:** Schools that fail to participate after entering and who fail to formally withdraw will be fined \$100.00 (additional penalties may apply, refer to Terms and Conditions). The fine is necessary to encourage schools to make us aware of their intent not to participate. When schools do not show up, it adversely affects the balance in the numbers of teams assigned to each Sectional. This can create situations that are unfair to others.

If you have Track & Field questions relative to this or any information you have reviewed, please contact us:

**Contact Us**

Ron McGraw, IHSA Track & Field Administrator: [rmcgraw@ihsa.org](mailto:rmcgraw@ihsa.org)  
Cheryl Lowery, Administrative Assistant: [clowery@ihsa.org](mailto:clowery@ihsa.org)  
Phone: 309-663-6377 — Fax: 309-663-7479

# IHSA School Center Website Login Instructions

## Sport/Activity Tracker Information

### Access to Track & Field Web Page

(School password and ID number is not required).

Please follow the steps below:

1. On the World Wide Web Go to: [www.ihsa.org](http://www.ihsa.org)
2. Click on the pull down menu under Sports & Activities.
3. Click on Girls and/or Boys respective sports page  
On this page, you will find Links for
  - **State Series Information & Results** (Upper left hand corner):  
Sectional Sites, Sectional Assignments, Sectional Results,  
State Final Qualifier Information, State Final Results
  - Records & History
  - Advisory Committee Information
  - 5-year Season Calendar

### STATE FINAL MEET

- **1A, 2A & 3A:** Thurs.-Sat., May 21-23, 2015
- **Site:** O'Brien Stadium, Charleston
- **Lodging:** EIU Housing Instructions | City of Charleston | City of Mattoon
- **Apparel & Souvenirs:** Minerva

### ANNOUNCEMENTS

Important Notice of NFHS Pole Vault Rule Change: Pole Vault Planting Box Padding

Free Pole Vault Skills Course Now Available Through NFHS Coach Education

Guidelines for Non-School Competition

Host Rotation through 2021: Class 1A, Class 2A, Class 3A

### RESOURCES (Links will become active (underlined) as information becomes available)

- [Quick Facts](#)
- [State Series Information & Results](#)
- [Terms & Conditions](#)
- [Summary of IHSA Boys and Girls Track & Field Series, Wheelchair Division](#)
- [Manual for Schools](#)
- [Manual for Managers](#)
- [Seeding Procedures](#)
- [Track & Field Bulletin](#)
- [State Final online Volunteer Registration](#)
- [Non-Licensed Volunteer Officials Registration](#)
- [2015 FAT Qualifying Standards](#)
- [Rules Presentation \(Must be logged into the Schools Center with Coaches User ID and password to receive credit\)](#)
- [State Final Volunteer Assignments](#)
- [State Final Time Schedule](#)
- [State Final Qualifier Information](#)
- [Race at State Open Track Races](#)
- [Track & Field Disability Sports Organizations](#)
- [History of the Movement \(video about the Paralympics\)](#)
- [Courage Center \(videos and related material\)](#)

### Access to IHSA Schools Center Web Page

**To access the School Center, the User ID number and respective coach password is required.**

The School's Center Web Site can only be accessed with your User ID and respective coach password. Your school is required to generate and email each coach a user ID and password. If a coach password is misplaced or forgotten, the coach should contact their school administration to reset their password through the IHSA Schools Center. An active/frequently used email address must be on file at the high school for coaches to receive their password.

**Coaches can Access the Schools Center with their unique Coaches password by following the steps below:**

1. On the World Wide Web Go to: [www.ihsa.org](http://www.ihsa.org)
2. Click on School's and Officials Center login
3. Enter your Coaches User ID
4. Enter Coaches password
5. With this access, coaches will be able to view and complete items and watch for important deadlines to keep your team/individuals eligible to compete in their IHSA sport/activity.
  - [Rules Meeting Bulletin](#)
  - [Rules Meeting Video \(yearly Head coach requirement\)](#)
  - [Online List of Participants](#)
  - [Manual for Schools](#)
  - [PES Exam \(1 time coach requirement\)](#)
  - [Concussion Video Exam \(every 2 years coach requirement\)](#)

### Sport and Activity Tracker within the Schools Center

Once logged-in to your Schools Center, you will notice important dates and deadlines pertaining to coaching responsibilities.

**Important:** There is no qualifying tournament to be eligible to compete in the first qualifying level of any IHSA State Series Tournament. Once deadlines passes, the Sport and Activity Tracker will show if your school has met the required Sport/Activity deadlines. It will show:

1. Entry Status (indicates if your school team/individuals are signed up to participate in the current sport(s)/activity(s))
2. View the Rules Meeting Video and get credit
3. Check to see if your school was given credit for watching the Rules Video
4. Program Status (whether your school is on probation or suspension)
5. Review/print the Manual for Schools for the respective Sport/Activity (this should be reviewed by all coaches)
6. Participation Survey
7. Officials Top 15 List (not required)
8. Deadline dates for Required Forms for the respective Sport/Activity and verification that those reports have been sent to the IHSA Office.
9. Rating Officials (not required)

Enter user ID:  
  
 Enter password:



## Welcome to the IHSA Schools & Officials Center

To log in, please type your user ID in the upper box and your password in the lower box, then click the button.

Forgot your password? You can [reset your password](#) via email.

**SCHOOL PERSONNEL:** If you don't know your ID or password, please contact your athletic director or AD's assistant.

Have a question about clinics or rules meetings or other Officials Center items? Contact the [IHSA Officials Department](#).

The Schools & Officials Center is closed every morning between 3 and 4 am Central Time.

Please report problems to the [IHSA Technology Department](#).

Scott Johnson  
A0000

IHSA (Test School)

[MAIN MENU](#)



jackie

Enter new selection:

Admin

### Departments

<b>T</b> Sport & Activity Tracker	<b>L</b> Staff Responsibilities & Logins
<b>I</b> School Information & Facility Maps	<b>E</b> Eligibility Requests & Rulings
<b>V</b> Voting & Town Meetings	<b>R</b> Special/SAWA Reports & Yellow Cards
<b>H</b> IHSA State Series Hosting & ScoreZone	
<b>O</b> Officials & Body Fat Testers	<b>D</b> Open Dates
<b>PES</b> Performance-Enhancing Substance Program	<b>CON</b> Concussion Risk Program
<b>A</b> All-Time Records	<b>S</b> Student Recognition
<b>W</b> Webinars	<b>F</b> Forms & Other Resources
<b>P</b> Personal Information	

### Office Shortcuts

**LOP:** GOG GOB TNG CCG cDc CCB cDB SWG SDG  
 DAC CHC BWB BDB BWL BDC CT IE GYG SWB SDB WR DB DGI  
 JRN BSF GYB BAD TRG TDG TRB TDB TNB **Sched:** FB

**SUM:** SOB VBG FB WR BKG BKB SCB  
 WPG WPB VBB SOG SBG BA

**SFI:** SOB VBG FB xGYG WR BKG BKB SCB  
 WPG WPB xGYB VBB SOG SBG BA

[View an overview of the new concussion exam requirement](#)

### Message Center

If you're interested in hosting IHSA State Series events, now is a good time to revisit your [facilities](#) and [host availability](#) surveys.

6 days ago

[2014-2015 All-School Mailing](#)

One week ago

[Concussion Course now available](#)

[Concussion Course for Coaches update](#)

[View older messages →](#)

**8/5 2014-2015 All-School Mailing**

High School Administrators:

### Quick Links

Log out

Scott Johnson  
A0000

IHSA (Test School)

MAIN MENU



jackie

Enter new selection:

Find

Admin

## IHSA Sport & Activity Tracker

**TRACKER:** [Action items only](#) | [Fall sports](#) | [Winter sports](#) | [Spring sports](#) | [Activities](#) | [All sports & activities](#)  
[Entry form](#) | [Coop teams](#) | [Emerging sports](#) | [Participation summary](#) | [Ratings summary](#)

This page tracks the progress your sport and activity programs have made in completing items required for IHSA State Series.  
**Red cells** indicate action items. It is your responsibility to **get the red out!**

You may still [enter your programs](#) in IHSA state series for the current school term. In some cases a late penalty may apply.

BOYS GOLF	Status of Head Coach	Status in IHSA State Series	Status of Program	Online Forms	Rating of Officials	Documents, Printed Forms and Other Information
	<b>Scott Johnson</b>	<a href="#">enter your school deadline is 9/5</a>	probation	<a href="#">Participation Survey</a> has not yet been submitted		<a href="#">Terms and Conditions</a>
<b>Class 3A</b>	coaching qualification: ISBE certification PES exam passed on 8/12/13		view rules video starting 8/12 until 9/16			
<a href="#">email task reminder to coach</a>	concussion exam passed on 8/1/14					<a href="#">Case situations</a>

GIRLS TENNIS	Status of Head Coach	Status in IHSA State Series	Status of Program	Online Forms	Rating of Officials	Documents, Printed Forms and Other Information
		<a href="#">enter your school deadline is 9/5</a>	probation	<a href="#">Participation Survey</a> should be submitted on fifth day of practice		<a href="#">Terms and Conditions</a>
			view rules video starting 8/12 until 9/16			<a href="#">School Manual</a>
<a href="#">email task reminder to coach</a>				Lists of Participants from sectional schools will be available morning after LOP deadline		<a href="#">Case situations</a>

BOYS SOCCER	Status of Head Coach	Status in IHSA State Series	Status of Program	Online Forms	Rating of Officials	Documents, Printed Forms and Other Information
	<b>Wilfred Jamieson</b>	<a href="#">enter your school deadline is 9/5</a>	probation	<a href="#">Participation Survey</a> should be submitted on fifth day of practice		
<b>Class 3A</b>	coaching qualification: ISBE certification PES exam passed on 7/23/14		view rules video starting 8/12 until 9/16			
<a href="#">email task reminder to</a>	concussion exam is expired and must be					<a href="#">Case situations</a>



# Sectional Checklist for Coaches

Please use the following Sectional Checklist for Coaches, to assist you in completing various tasks and making sure you have submitted various forms by deadline dates that are important to your school's participation in the IHSA Girls and Boys Track and Field State Meet Series.

## Prior to the Sectional Seed Meeting

- ( ) Read carefully the IHSA Track and Field Series Terms and Conditions within this manual.
- ( ) Review all portions of the IHSA Track and Field Manual that pertain to your school's participation in the IHSA Track and Field State Meet Series.
- ( ) **Online List of Participants: Deadline, noon Monday prior to Sectional Seeding Meetings. Complete Instructions are included in this manual.** This is probably the most important job as a coach to ensure your athletes are eligible to compete in the IHSA State Series. Please proof-read your work and double-check it. **Make sure you use all drop down boxes (8) when completing each relay.** We see time and time again, errors that can be avoided, if time is given to this process. (Athletes become ineligible because the coach didn't include them in the Online List of Participants). **BE EXTREMELY CAREFUL AS YOU CREATE YOUR LIST OF PARTICIPANTS. YOUR ATHLETES ARE COUNTING ON YOU TO ENTER THEM INTO THE APPROPRIATE EVENTS AND SPELL THEIR NAME CORRECTLY!**

**PRINT A COPY OF EACH PAGE OF YOUR ONLINE LIST OF PARTICIPANTS BEFORE THE DEADLINE! (press CTRL+P on your keyboard). This is the proof of who you entered and which event(s) they will be competing in!**

- ( ) Coaches are not required to attend the Sectional Seed Meeting (however, attendance is highly recommended). It is important to remember that the procedures outlined in the Terms and Conditions must be followed in submitting your List of Participants to the Sectional Manager. If the procedure is not followed, competitors and or coaches from your school will not be permitted to participate in the Sectional meet. If you can not attend the seeding meeting you must send the host school documentation to support the seeding times you have submitted. Failure to do so may result in the coaches present at the seed meeting not accepting a time you have submitted. It is your responsibility as the coach to be capable of defending and documenting any and all times submitted for seeding. It is for this reason that it is extremely important to all athletes that all coaches be present at the seeding meeting. No one from the meeting is required to contact absent coaches if questions concerning seed times are raised during the seeding process.
- ( ) The Sectional Seed Meeting will be held at the Sectional center on Tuesday, prior to the Girls and Boys Sectional Meets. If you have not been informed, contact your Sectional Manager to find out the time and place of the meeting. Send appropriate documentation if you are unable to attend the seeding meeting.

## At the Sectional Seed Meeting

- ( ) Coaches may change or decrease the total number of individual entries submitted on-line at the sectional seeding meeting. An individual entry left blank during the on-line entry process can not be filled at the sectional seeding meeting. Times may be changed at the seeding meeting in any event. No substitutions or changes shall be permitted in the individual events after the Sectional Seeding Meeting, except in cases of a substitution made because of school disciplinary reasons, a death in the athlete's immediate family, or a disabling illness or injury to an entered contestant which must be certified in writing by either the high school principal or attending physician to the Sectional manager. No substitutions are allowed after the meet begins. **NO CHANGES ARE ALLOWED TO YOUR LIST OF RELAY CONTENDANTS AFTER THE ENTRY DEADLINE HAS PASSED. ONLY CHANGES TO INDIVIDUAL ENTRIES AND TIMES ARE ALLOWED AT THE SEEDING MEETING.**
- ( ) Make sure you do not enter a competitor in any event unless he/she will participate in the State Final meet if he/she qualifies to advance. Doing otherwise is unfair to other competitors.
- ( ) Assist the Sectional Manager in whatever way is needed to complete the seeding for the Sectional meet, in accordance with seeding instructions in this Manual. Coaches unable to attend should send documentation to the host prior to the seeding meeting. Failure to do so may result in a contestant receiving a lower seed by the coaches present.
- ( ) Participate in determining the Games Committee for your Sectional meet. The Games Committee shall also serve as the Jury of Appeals. It should include the Sectional Manager and four (4) head coaches selected from among the head coaches present at the Sectional Seed Meeting. No rules may be set aside by the Games Committee or Jury of Appeals.
- ( ) Review the role and duties of the Meet Referee, Games Committee and Jury of Appeals.
- ( ) Elect a Sectional Representative who will be responsible to send a written report of the coaches' suggestions from your Sectional meet to the IHSA Office prior to June 15.
- ( ) Important! Review the Sectional heat sheet to make sure all your school's participant information is accurate before leaving the Sectional Seed Meeting. The information provided from your school for the heat sheets is imported by IHSA and used in the State Final Program.
- ( ) Often schools hosting Sectional Meets must depend on the cooperation and assistance of the coaches from participating schools to provide knowledgeable, experienced, trained adults to assist with the officiating and conduct of the Sectional meet. The terms and condition requires each school entered in the T&F state series to provide one qualified volunteer from your school to help conduct the Sectional Meet. Please follow through with this important responsibility and make certain that the volunteer you provide the host is qualified. Track & Field is unique in this respect. We must be able to count on each other at times in order to provide the best opportunities for our athletes. Again, the terms and conditions now require each participating school to provide one qualified volunteer to help the sectional host conduct the sectional meet.

### Following the Seeding and Prior to the Sectional Meet

- ( ) In accordance with the Terms and Conditions, no name changes can be made to your school's relay entries. Only changes pertaining to typographical spelling errors and/or in an individual entry may be made in accordance with the substitution provisions. The Principal/Official Representative must verify in writing to the Sectional Manager that the substitution is because of school disciplinary action, a death in the athlete's immediate family or a disabling illness or injury (not allowed after the meet begins).
- ( ) If you have been asked/assigned to provide qualified adult personnel to serve as assistant officials or meet personnel for the conduct of the Sectional meet, make sure you select and/or train these persons so they will be knowledgeable about the job they are to perform. Be sure you give instructions to these volunteer officials or meet personnel so they will know where and when they are to report for duty and/or a pre-meet meeting with the Meet Referee, etc.

### At the Sectional Meet

- ( ) Scratches may be made in accordance with the Track and Field Rules.
- ( ) Make sure you and your competitors do not leave the Sectional Site until at least one-half hour after the last event in which your school participated; until all final appeals have been decided in the events in which your school has participated; or, until you have received the official results for each of the events in which your school entered competitors.
- ( ) Before leaving the Sectional Site, make sure the Sectional Manager has correctly identified winners and additional qualifiers from your school who have qualified for the State Final meet.

### Following the Sectional Meet

- ( ) Notify the IHSA Office immediately if any of your school's State Final qualifiers has a disabling injury or illness that will prevent him/her from participating in the State Final meet, or if a competitor will not be permitted to participate in the State Final meet due to school disciplinary reasons.
- ( ) Sectional Meet Managers must complete the Winner Report and upload the complete results directly to the IHSA Schools Center immediately following the Sectional Meet. If you notice an error, contact Cheryl Lowery immediately (clowery@ihsa.org). Only those errors reported by Tuesday at 8:00 a.m. will be corrected for the Thursday Preliminary State Final Program.

### For the State Final Meet

- ( ) Review the State Final Procedures posted on the IHSA girls and boys track activity pages.
- ( ) Make housing reservations for the competitors from your school. For reservations, contact Director of Housing, Eastern Illinois University, Charleston, IL 61920. Phone: (217) 581-5111, or (217) 581-5633.
- ( ) You may refer parents and fans from your community to the IHSA Web Site for information pertinent to this year's IHSA Track & Field State Finals.

- ( ) Practice (State Final): Team Packet Pick-up will be at the South Ticket window on the west side of O'Brien Stadium (parking lot side)

IHSA Staff will be available during the following times for packet pick up. Class 2A and 3A teams who plan to attend the 1A state final, must pick up their team packets (bib numbers are your only ticket for free access to O'Brien Stadium):

Wednesday: 4:00 p.m.-7:00 p.m.

Thursday: 8:00 a.m. - 6:00 p.m.

Friday: 8:00a.m. – 2:00 p.m.

### Practice at the State Final:

Schools may use the track and field facilities at O'Brien Stadium for practice and warm-up. These practice sessions are not the responsibility of the IHSA nor of EIU. Athletes and coaches use the facilities to practice at their own risk. Coaches will be responsible for the safety of their athletes/staff. Coaches must be aware of the weather and react according to IHSA severe weather safety guidelines. (If it roars, go indoors!).

- 1) On Wednesday afternoon, 1A competitors will be permitted to warm-up on the track from 4:00 p.m. until 7:00 p.m., and between 8:00 a.m. and 10:00 a.m., on Thursday morning. On Thursday night from approximately 5:00 p.m. until 7:00 p.m. (approx. 30 minutes following the 1A meet), the track will be open for 2A and 3A competitors for practice. On Friday morning the track will be open for 2A and 3A competitors from 7:00 a.m. until 8:30 a.m. On Saturday morning the track will be open from 7:00 a.m. until 8:45 a.m. for warm ups. The track will be cleared after these special warm-up times. Contestants shall not use the space inside O'Brien Field for warm-up or practice on the days of the State Final except at the above designated times. The track will be cleared on Wednesday and Thursday after all warm-up times have expired.
  - 2) Contestants warming up at other than the above times during the meet may use the southeast area behind the tennis courts and the area behind the East bleachers or Lantz Fieldhouse, but shall not use unauthorized or off limits areas.
  - 3) Field Event Warm-up: The Head Judge in each field event will conduct a maximum 15-minute warm-up prior to the beginning of competition in each flight in the field events. Competitors who report promptly to the Head Judge may participate in this warm-up. Exception: The discus competition will be permitted a 20-minute warm-up period.
- ( ) Review the time schedule for the State Final meet semifinals and finals with your athletes. The starting height for the Pole Vault and High Jump will be determined by the Games Committee and posted on the IHSA Web Site (www.ihsa.org) on Tuesday prior to the State Final meet.

- ( ) A Scratch card will be included in State Final Team packets. Please complete it and turn it in to the Clerks Tents as soon as you know of a scratch. This will prevent coaches from unnecessarily being called to the Clerks tent for "no-shows" and alert the Clerk of Course of any scratches. Additional forms will be available in the clerks tent, if needed.

# 2015 IHSA Online List of Participant Instructions

We have put together this page to help in the process of completing your schools Online List of Participants for Track & Field. Step-by-Step diagrams of what you will see when you are logged in to the IHSA Schools Center are included on the next page. This is probably the most important job as a coach to ensure your athletes are eligible to compete in the IHSA State Series. A school may enter up to 8 names per relay. Relays cannot be changed after the deadline. Make sure you have selected a name for each of the 8 **drop-down boxes when completing each relay**. Please proof-read your work and double-check it before the deadline. We see time and time again, errors that can be avoided, if time is given to this process. (Athletes become ineligible because the coach didn't include them in the Online List of Participants). **BE EXTREMELY CAREFUL AS YOU CREATE YOUR LIST OF PARTICIPANTS. YOUR ATHLETES ARE COUNTING ON YOU TO ENTER THEM INTO THE APPROPRIATE EVENTS AND SPELL THEIR NAME CORRECTLY!**

**PRINT A COPY OF EACH PAGE OF YOUR ONLINE LIST OF PARTICIPANTS BEFORE THE DEADLINE! (press CTRL key+P) on your computer keyboard. This is the proof of who you entered and which event(s) they will be competing in!**

You must complete every page and save it when complete.

The entry form requires you to list all participants in the events to which they will be competing in at the sectional meet. Substitutions for relays can only be done by using one of the eight from the respective relay entered before the List of Participant deadline. Once the List of Participant deadline expires, no changes are allowed to any relay contestants.

## INSTRUCTIONS TO COMPLETE THE ONLINE LIST OF PARTICIPANTS

Go to [www.ihsa.org](http://www.ihsa.org)

- 1) Click on "School & Officials Center Login"
- 2) Enter your "User ID" (5 digits, a letter followed by a number) and the password issued to you by your school. All of this information was emailed to you by your school. IHSA login ID and your unique Track & Field Coaches password (Boys and Girls Coaches have different passwords), issued through your school administration through the IHSA Schools Center.
- 3) Click on Sport & Activity Tracker
- 4) Click on the "List of Participants" link
- 5) Type in the requested information and save your page(s).
- 6) **Certify & Submit your Form**
- 7) **PRINT EACH PAGE (ctrl key+P) on your computer keyboard. After the deadline, you will not be able to do so.**

**Why:** This is how the IHSA knows the names of the participants and coaches. This information will later be used in the State Final Program. It will be used as it is presented so please double check spellings for accuracy.

### Reasons for the "Red Box" to appear in the Sport/Activity Tracker:

- ❖ Schools would not verify to have competed in at least 6 Contests if they only entered as an individual (team honors only).
- ❖ School hasn't completed the "Certify & Submit" page.

Once the deadline date approaches, the Schools Center Activity Tracker will show that the deadline has passed. This does not mean your school didn't complete it. It means the IHSA Office has imported all rosters and is in the process of preparing the files for the host of your Regional/Sectional Managers.

**Wheelchair Track List of Participants:** Instead of clicking on Track List of Participants, you will click on Wheelchair Track List of Participants. This category will be on the line below the Track List of Participants in the activity tracker - Type in the requested information and save your page(s) as you proceed.

### **Verification of IHSA Receiving List of Participants:**

- Print a copy once you have completed the Sectional entries. This is your verification and if necessary, you can provide proof of your entries at the Sectional Seeding Meeting, in case of computer or file download error (very rare).
- Make sure you click on the "Certify & Submit PAGE" so you will not receive unnecessary reminders from our office about not receiving your Track & Field List of Participants.

### **Page 1=Instructions**

Be sure to fill out each page of the List of Participants Form by clicking through the links in the yellow box at the top of the page.

On the **Roster page**, you should enter the names of students who **might compete** in the state series.

On the **Participants page**, you can then designate which of these students will **actually compete in the state series**. **This is the data that your sectional manager will receive as your Sectional List of Participants.**

You may move back and forth between the pages and make changes at any time before the deadline.

When you are finished, review the Participants page and then "Certify & submit" the form. (You may still return to the form any time before the deadline to make changes.)

## Page 2 = Coaches Page/Staff Compliance in the IHSA Schools Center

**Who:** Principal, Official Representative, Athletic Director

**When:** By February 1

**Where:** IHSA.org

**How:** Go to www.ihsa.org

1) Click on IHSA Schools & Officials Center Login

2) Enter your User ID (5 digit ID, a letter followed by 4 letters) and Official Representative or Principal password

3) Click on Staff Compliance

**Why:** This page is very important because if any information is missing from the coaching profile, the coach will not be able to add his/her name to their list of coaches on their List of Participants and will not be issued credentials at the State Final. This page indicates:

- a. Who has been listed as coaches for your school (AD, Principal, Official Representative)
- b. How each coach on your staff is certified to coach-*ie.*: ISBE/ASEP/NFHS. (AD, Principal, Official Representative must complete this information).
- c. If the coach has completed the PES Exam (one time requirement)
- d. If the coach has passed the Concussion Exam (every two years)

(To make changes to this information you should click on the "Staff Logins & Roster" link and click the name of the person you want to edit and make necessary changes.)

Please be aware that in order to be listed as a coach all the above requirements must be accounted for in the job/coaching profile in the IHSA Schools Center. **If the name of your coach doesn't appear in the drop-down menu, it is an indication that all or part of their coaching requirement information is missing from their IHSA Schools Center. Until their coaching profile in the IHSA Schools Center is complete, their name will not appear and they are an ineligible coach (contact your Athletic Director, Officials Representative or Principal to update the information). Coaches will not receive coaching credentials during the state series unless their Schools Center coaching profile requirements have been completed.**

## Page 3 = Roster

On this page coaches should enter the name of any student who **might compete** in the IHSA state series.

**TIPS:** Tab between the fields. Hit "S" twice for "So." Tab over to the button and hit Enter to add the name.

## Page 4 = Participants

On this page, you can then designate which of these students will **actually compete in the state series**. There are many boxes on this page. It would be wise to save your changes after filling in each event. If a name does not appear in the pull-down menu, or if it is misspelled, please return to the Roster (page 3) to fix the problem and return to this page to select them. The data on this page is what your Sectional Manager will receive from IHSA to seed their meet. **IMPORTANT: If you make any changes in the Roster, you MUST go back to the Participants page and re-add that person to their event(s)!**

After editing this page, be sure to press the button to save your changes.

**Page 5 = Certify, Submit and PRINT (press CTRL+P) on your computer keyboard by: May 11, 2015 (Girls)/May 18, 2015 (Boys) at noon**

If you have any questions, please don't hesitate to call.

Cheryl Lowery

Phone: 309-663-6377 –or-- Email: clowery@ihsa.org

# Prevention of Heat Illness Guidelines

Athletes participating outdoors in hot, humid weather or indoors, in non-air conditioned or poorly ventilated gyms are susceptible to heat related illness. While it is the responsibility of each school participating in an IHSA contest to allow adequate acclimatization to the heat prior to the contest, it is the authority of the local manager to adjust or alter a contest based on the environment. Managers should check the environment one-hour before the scheduled contest.

If a high risk is present, the manager has the authority to alter game conditions. Athletes should drink one to two cups of water in the hour preceding competition and continue drinking during the activity every 15-20 minutes. If conditions become severe the manager may suspend or alter the contest. Altering the contest may include stoppage of play for a mandatory drink period, stopping play for a rest period where gear and clothing may be loosened to allow heat loss, stopping play to allow for removal of outer clothing, socks and or shoes or even postponing the contest.

Local Managers should refer to the Heat Index Table below if the host school does not have a plan or means to assess both the temperature and humidity prior to the contest. This heat index can be used to define low, moderate, high and extreme risk conditions.

## Heat Index Chart

Heat Index in °F (°C)

Temp in °F/°C	Relative Humidity (%)												
	40	45	50	55	60	65	70	75	80	85	90	95	100
110 (47)	136 (58)												
108 (43)	130 (54)	137 (58)											
106 (41)	124 (51)	130 (54)	137 (58)										
104 (40)	119 (48)	124 (51)	131 (55)	137 (58)									
102 (39)	114 (46)	119 (48)	124 (51)	130 (54)	137 (58)								
100 (38)	109 (43)	114 (46)	118 (48)	124 (51)	129 (54)	136 (58)							
98 (37)	105 (41)	109 (43)	113 (45)	117 (47)	123 (51)	128 (53)	134 (57)						
96 (36)	101 (38)	104 (40)	108 (42)	112 (44)	116 (47)	121 (49)	126 (52)	132 (56)					
94 (34)	97 (36)	100 (38)	103 (39)	106 (41)	110 (43)	114 (46)	119 (48)	124 (51)	129 (54)	135 (57)			
92 (33)	94 (34)	96 (36)	99 (37)	101 (38)	105 (41)	108 (42)	112 (44)	116 (47)	121 (49)	126 (52)	131 (55)		
90 (32)	91 (33)	93 (34)	95 (35)	97 (36)	100 (38)	103 (39)	106 (41)	109 (43)	113 (45)	117 (47)	122 (50)	127 (53)	132 (56)
88 (31)	88 (31)	89 (32)	91 (33)	93 (34)	95 (35)	98 (37)	100 (38)	103 (39)	106 (41)	110 (43)	113 (45)	117 (47)	121 (49)
86 (30)	85 (29)	87 (31)	88 (31)	89 (32)	91 (33)	93 (34)	95 (35)	97 (36)	100 (38)	102 (39)	105 (41)	108 (42)	112 (44)
84 (29)	83 (28)	84 (29)	85 (29)	86 (30)	88 (31)	89 (32)	90 (32)	92 (33)	94 (34)	96 (36)	98 (37)	100 (38)	103 (39)
82 (28)	81 (27)	82 (28)	83 (28)	84 (29)	84 (29)	85 (29)	86 (30)	88 (31)	89 (32)	90 (32)	91 (33)	93 (34)	95 (35)
80 (27)	80 (27)	80 (27)	81 (27)	81 (27)	82 (28)	82 (28)	83 (28)	84 (29)	84 (29)	85 (29)	86 (30)	86 (30)	87 (31)

Category	Heat Index	Possible heat disorders
Extreme Danger	130° F or higher (54° C or higher)	Heat stroke or sunstroke likely
Danger	105°-129° F (41°-54° C)	"Sunstroke, muscle cramps, and/or heat exhaustion likely. Heatstroke possible with prolonged exposure and/or physical activity.
Extreme Caution	90°-105° F (32°-41° C)	"Sunstroke, muscle cramps, and/or heat exhaustion possible with prolonged exposure and/or physical activity.
Caution	80°-90° F (27°-32° C)	Fatigue possible with prolonged exposure and/or physical activity.

• reproduced from NWS, Birmingham, AL

# IHSA Severe Weather Safety Guidelines

*To be used during any IHSA state series contest*

When thunder is heard, or a cloud-to-ground lightning bolt is seen, the thunderstorm is close enough to strike your location with lightning. Take shelter immediately.

Lightning is one of the most consistent and underrated causes of weather-related deaths or injury in the United States. Nearly all lightning-related injuries occur between the months of May and September and between the hours of 10:00 a.m. and 7:00 p.m. Therefore, the greatest concern for injuries in an outdoor contest appears to be during that time, though it can happen any time of year.

It is essential that local managers, competing schools, and contest officials establish dialogue in advance of contests or events to ensure that all involved are aware of what the plan will be in determining whether or when to suspend play. Local managers are encouraged to share their plan with competing schools and assigned contest officials *prior to the start of the tournament/event*.

## Advance Planning:

Local Managers should have a documented plan in place, designated people who are responsible for monitoring the weather and a qualified person (typically a trained manager and/or officials) to make the decision to suspend play. In state series competitions, the local tournament manager or official(s), if assigned, can make the decision to suspend play.

## Monitoring Weather:

Local Managers during the contest should be aware of any potential thunderstorms that may form during the competition; if an evacuation is needed, managers should also know how long it would take teams to get to their safest location. Monitoring the weather with a weather alert radio, or with lightning detection systems, or any other available means, is recommended.

If competing schools have portable devices they will be bringing to a contest/event and/or have specific policy or directions from their administration that they must follow, the school must communicate those to the tournament manager. Tournament managers must know the policies of each school assigned to their tournament or event prior to its start.

## Lightning Awareness

Generally speaking, it is felt that anytime a cloud-to-ground strike of lightning can be seen, or thunder heard, risk is already present. It is time to seek shelter.

## Criteria for Suspending Play

If the local management does not have commercial weather warning equipment at the site or an efficient method of making an accurate, timely decision on location, listening for thunder is the best way to mitigate the danger. If thunder is heard, or lightning is seen hitting the ground, the thunderstorm is close enough to strike in your location. According to the National Weather Service, lightning can strike 10 miles away from the parent thunderstorm. When thunder roars, go indoors! It is important that local manager monitor not only how far away the lightning is but also how fast it is approaching. Thunderstorms can form and move quickly and danger can arrive quickly.

Either tournament/event management or assigned contest officials have the authority to suspend or cancel interscholastic contests. It is recommended that those groups work together in making such determination and use any and all available information in doing so. Participating schools with concerns at particular events should direct those to tournament/event management or assigned contest officials.

The following guidelines should be followed in determining when to suspend an event:

1. Anytime a cloud-to-ground strike of lightning can be seen, or thunder heard, risk is present, and a contest should be suspended. At that point, the 30 minute rule for resumption should go into effect.  
**NOTE:** *Due to the layout of some outdoor facilities, contest officials or tournament managers may not be able to see lightning actually "strike the ground." However, whenever lightning is seen moving out of clouds towards the ground, it can be assumed that the lightning is, in fact, striking the ground somewhere, and, as a result, the contest should be suspended.*
2. If lightning or thunder is not present but the weather is starting to become ominous, tournament management and/or contest officials should use all available information to determine if and when a contest should be suspended. Care for both participants and spectators should be taken into account at this point. If in doubt, contest officials or tournament managers are encouraged to exercise caution and suspend play. At such a point, tournament officials should be ready to implement their emergency plans. However, competing schools who pull their teams or athletes off a field of competition prior to a contest or event's suspension do so at the risk of forfeiture or disqualification from the game or event.
3. Suspended contests or events should be resumed at a time when the weather and/or field conditions allow for resumption.

## Evacuation Plan

**Safe Areas:** All personnel, athletes and spectators should be clearly informed of available safe structures or shelters in the event a thunderstorm approaches. A safe structure is any fully enclosed building frequently used by people. In absence of that – athletes and spectators should go to any vehicle with a hard metal roof. Roll up the windows and do not touch the sides of the vehicle. If no safe structure or vehicle is available, find a thick grove of small trees surrounded by taller trees or a dry ditch. Assume a crouched position on the ground with only the balls of your feet touching the ground. Wrap your arms around your knees and lower your head. Minimize contact to the ground since lightning often travels through the ground.

**Avoid:** Tall trees or objects like light poles or flagpoles, individual trees, standing pools of water and open fields. Also avoid being the highest object on the field. Do not take shelter under trees. Avoid bathrooms if another building is available, and do not use a land-line telephone. A cellular phone or portable phone is a safe alternative if in a secure shelter or vehicle.

## Resuming Activity

The NSSL (National Severe Storms Laboratory) recommends that everyone should wait at least 30 minutes after the last flash of lightning or sound of thunder before returning to the field or activity.

## Concussion Information

### Mandatory Concussion Course for Coaches

House Bill 5431 will go into effect for the 2014-15 school year. The legislation requires ALL high school coaches and athletic directors to receive a certificate of completion every two years for an online concussion awareness and education program developed by the IHSA.

The program includes a presentation and other supplementary materials that ALL high school coaches and athletic directors need to review prior to taking a required exam over the curriculum. Individuals will be required to demonstrate proficiency on the exam by scoring at least 80% in order to serve as an athletic coach at an IHSA member school. The legislation also requires student-athletes to watch the video presentation portion of the over-all curriculum each year.

The program includes information on concussion awareness training, concussion recognition, best practices for avoiding concussions, return to play guidelines, and sub-concussive head trauma. Coaches will be able to access the program after logging into the IHSA Schools Center and clicking on the "CON" tab, which will be located under the 'Departments' heading on the Schools Center homepage.

### Return to Play (RTP) Policy

**Background:** With the start of the 2010-11 school term, the National Federation of State High School Associations (NFHS) implemented a new national playing rule regarding potential head injuries. The rule requires "any player who exhibits signs, symptoms, or behaviors consistent with a concussion (such as loss of consciousness, headache, dizziness, confusion, or balance problems) shall be immediately removed from the game and shall not return to play until cleared by an appropriate health care professional." In applying that rule in Illinois, it has been determined that only certified athletic trainers and physicians licensed to practice medicine in all its branches in Illinois can clear an athlete to return to play the day of a contest in which the athlete has been removed from the contest for a possible head injury.

**Policy:** In cases when an athlete is not cleared to return to play the same day as he/she is removed from a contest following a possible head injury (i.e., concussion), the athlete shall not return to play or practice until the athlete is evaluated by and receives written clearance from a licensed health care provider to return to play.

For the purposes of this policy, licensed health care providers consist of physicians licensed to practice medicine in all its branches in Illinois and certified athletic trainers working in conjunction with physicians licensed to practice medicine in all its branches in Illinois.

ILLINOIS HIGH SCHOOL ASSOCIATION

2715 McGraw Drive • Bloomington, IL 61704

• [www.ihsa.org](http://www.ihsa.org) • Phone: 309-663-6377 • Fax: 309-663-7479 •

## IHSA Protocol for Implementation of NFHS Sports Playing Rule for Concussions

**“Any athlete who exhibits signs, symptoms, or behaviors consistent with a concussion (such as loss of consciousness, headache, dizziness, confusion, or balance problems) shall be immediately removed from the contest and shall not return to play until cleared by an appropriate health care professional.”**

The above language, which first appeared in all National Federation sports rule books for the 2010-11 school term, reflects a strengthening of rules regarding the safety of athletes suspected of having a concussion, but not a revision in primary responsibilities in these areas. Previous rules required officials to remove any athlete from play who was “unconscious or apparently unconscious.” This revised language reflects an increasing focus on safety, given that the vast majority of concussions do not involve a loss of consciousness. However, the revised language does not create a duty that officials are expected to perform a medical diagnosis. The change in rule simply calls for officials to be cognizant of athletes who display signs, symptoms, or behaviors of a concussion from the lists below and remove them from play.

**NOTE: The persons who should be alert for such signs, symptoms, or behaviors consistent with a concussion in an athlete include appropriate health-care professionals, coaches, officials, parents, teammates, and, if conscious, the athlete him/herself.**

### Definition of a Concussion

A concussion is a traumatic brain injury that interferes with normal brain function. An athlete does not have to lose consciousness (be “knocked out”) to have suffered a concussion.

### Behavior or signs observed indicative of a possible concussion

- Loss of consciousness
- Appears dazed or stunned
- Appears confused
- Forgets plays
- Unsure of game, score, or opponent
- Moves clumsily
- Answers questions slowly
- Shows behavior or personality changes
- Can’t recall events prior to or after the injury

### Symptoms reported by a player indicative of a possible concussion

- Headache
- Nausea
- Balance problems or dizziness
- Double or fuzzy vision
- Sensitivity to light or noise
- Feeling sluggish
- Feeling foggy or groggy
- Concentration or memory problems
- Confusion

This protocol is intended to provide the mechanics to follow during the course of contests/matches/events when an athlete sustains an apparent concussion. For the purposes of this policy, appropriate health care professionals are defined as: physicians licensed to practice medicine in all its branches in Illinois and certified athletic trainers.

1. During the pre-game conference of coaches and officials, the official shall remind the head coaches that a school-approved appropriate health care professional will need to clear for return to play any athlete removed from a contest for an apparent head injury.
2. The officials will have no role in determining concussion other than the obvious situation where a player is unconscious or apparently unconscious as is provided for under the previous rule. Officials will merely point out to a coach that a player is apparently injured and advise the coach that the player should be examined by the school-approved health care provider.
3. If it is confirmed by the school’s approved health care professional that the student did not sustain a concussion, the head coach may so advise the officials during an appropriate stoppage of play and the athlete may re-enter competition pursuant to the contest rules.
4. Otherwise, if an athlete can not be cleared to return to play by a school-approved health care professional as defined in this protocol, that athlete may not be returned to competition that day and is then subject to the IHSA’s Return to Play (RTP) Policy before the student-athlete can return to practice or competition.
5. Following the contest, a Special Report shall be filed by the contest official(s) with the IHSA Office through the Officials Center.
6. In cases where an assigned IHSA state finals event medical professional is present, his/her decision to not allow an athlete to return to competition may not be over-ruled.

Additional information regarding concussion has been made available to IHSA member schools and licensed officials and can be accessed on the IHSA Sports Medicine website at <http://www.ihsa.org/Resources/SportsMedicine.aspx>.



# Pole Vault Pit Specifications

**NOTE: New 2014-15, Must use the Pole Vault Box Pad as per NFHS Track & Field Rule 7-5-22 that meets the ASTM Standard F2949.**

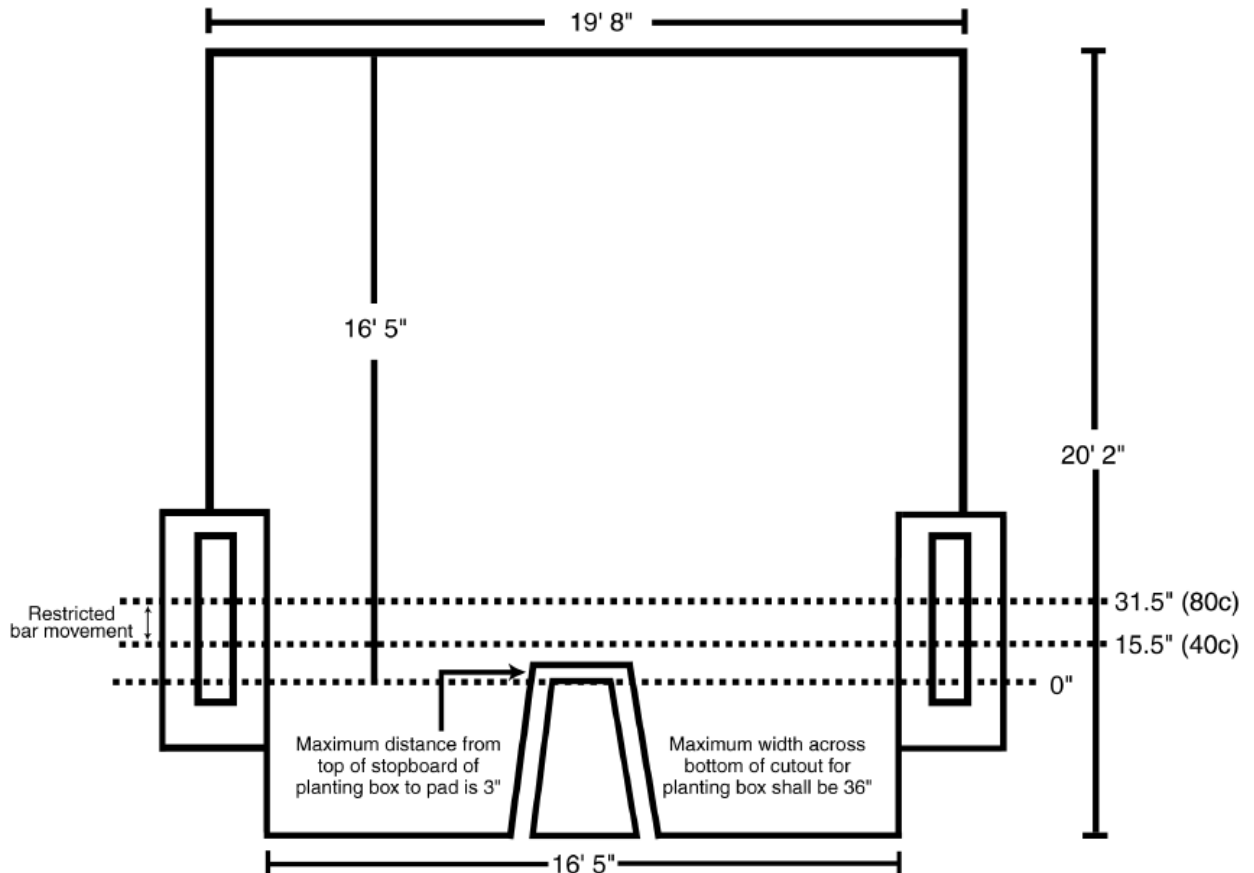
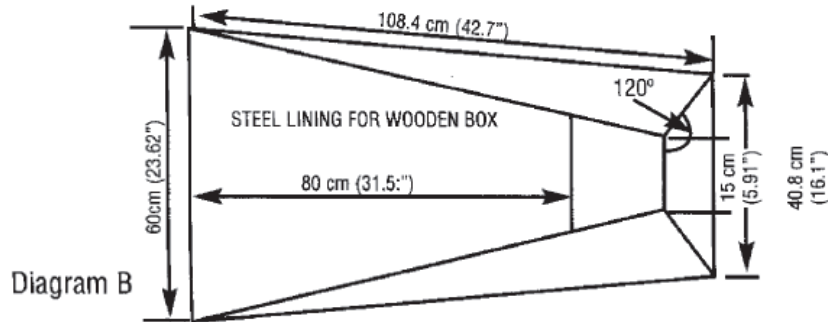
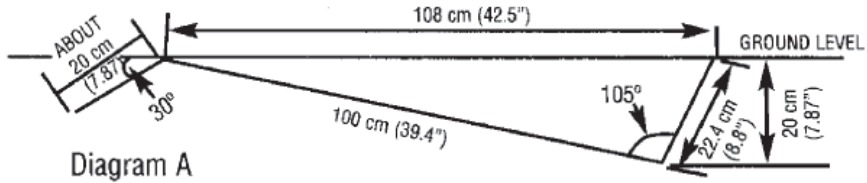

## Appendix B—34.92-Degree Throwing Sector Set-up

The 34.92 degree throwing sector is an isosceles triangle having two equal sides, with the base of the triangle always being .6 of the length of either side. The sector may be prepared by using three tapes and three people or one tape, two people and stakes to clearly designate measurements.

### 3-3 System: Example Shot Put

1. Measure out from center of the circle with two tapes. (Diagram A)
2. Pull two tapes tight and then separate them by 12 meters at the 20 meter mark on each tape. (Diagram B)
3. One person holds the two tapes which will locate the sector lines in the center of the circle. (Diagram B)
4. Second person pulls tight on one of the sector line tapes and holds the zero mark of the cross measuring tape at the 20-meter mark. (Diagram B)
5. Third person pulls tight on the other sector line tape and holds the 12-meter mark of the cross measuring tape at the 20-meter mark. (Diagram B)
6. Sector lines are centered on the stopboard and permanent pins or stakes are placed at the ends of sector lines. (Sector lines can be extended if longer throws are anticipated.) (Diagram C)

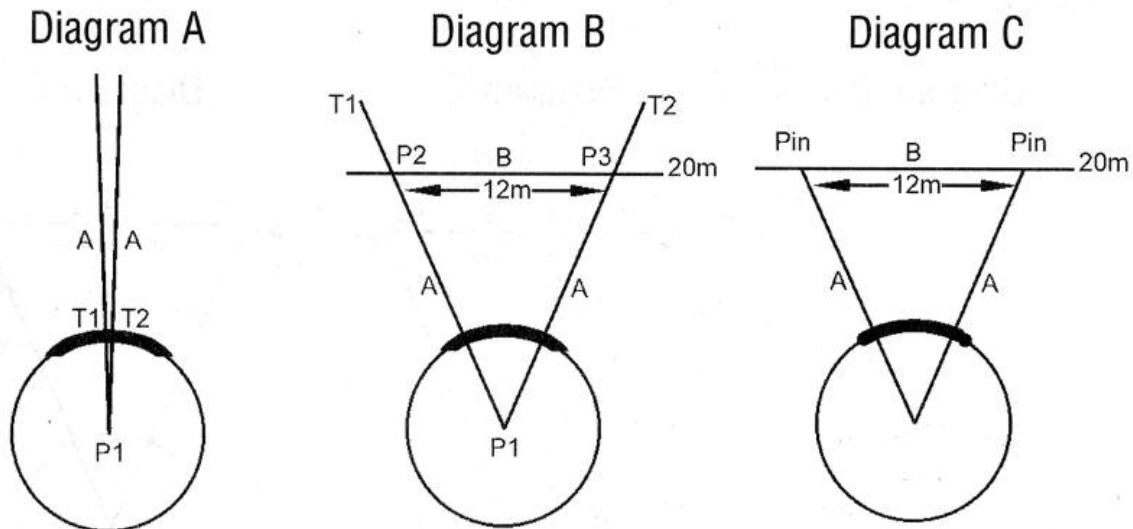

A=Sector line B=Cross measurement P=Person T=Tape

Sectors for the discus and hammer are set up in a similar manner, keeping the ratio of cross measurement length to sector line length at 0.6. For example, one might use sector lines of 60 meters and a cross measurement of 36 meters for the discus and 70 meters and 42 meters for the cross measurement for the hammer.

# Do What's Right!

## Sportsmanship

### DWR! EXPECTATIONS

- ❖ *Represents their school and community well with positive interaction with opposing fans and players.*
- ❖ *Uses positive yells, chants, songs or gestures.*
- ❖ *Display modesty in victory and graciousness in defeat*
- ❖ *Respect and acknowledge the integrity/judgment of officials.*
- ❖ *Exhibit positive behavior with opponents and fans before, during and after the contest.*

### Acceptable Behavior...

- During the National Anthem, students, participants and fans should remove any hats, face the flag, not talk, place the right hand on the heart, and remain still until the end of the anthem.
- Applause during introduction of players, coaches and officials.
- Players shaking hands with opponents while both sets of fans recognize player's performance with applause.
- Accept all decisions of the game officials.
- Spirit Participants lead fans in positive support.
- Handshakes between participants and coaches at the end of contests, regardless of the outcome.
- Treat competition as a game, not a war.
- Coaches/players search out opposing participants to recognize them for outstanding performance or coaching.
- Applause at the end of the contest for performance of all participants.
- Everyone showing concern for an injured player, regardless of the team.
- Encourage surrounding people to display sportsmanlike conduct.

### Unacceptable Behavior...

- Disrespectful or derogatory yells, chants, songs or gestures.
- Booming or heckling an official's decision.
- Criticizing officials in any way; displays of temper with an official's call.
- Yells that antagonize opponents.
- Refusing to shake hands or give recognition for good performances.
- Blaming the loss of the game on officials, coaches or participants.
- Laughing or name calling to distract an opponent.
- Use of profanity or displays of anger that draw attention away from the game.
- Doing own yells instead of following the lead of spirit participants.



# SCHOOL'S RESPONSIBILITY TO AN OFFICIAL PRIOR TO THE SEASON

1. Send a reminder card or email to the officials after you have them scheduled.
2. Reminder should include date of contest, time, level, location and sport.

Even though many schools and conferences have assignment chairpersons, sending a reminder is highly recommended. When an official does not show, people in your community won't know who the assignment chairperson is, but they do know the athletic director. **Avoid embarrassment.**

3. Have a standard wage scale set for your different sports and levels and a method in place to raise the pay periodically.
4. If possible, let the working officials know who their partner(s) will be.
5. Hire police and security along with medical assistant or athletic trainer coverage for events whenever possible.
6. Set a policy with your school board on fan, coach and player behavior.
7. Make sure all officials have a contract that is signed by your school—preferably by the principal or IHSA Official Representative.

## SCHOOL'S RESPONSIBILITY TO AN OFFICIAL PRIOR TO THE CONTEST

1. Prior to the contest, provide the officials with directions and inform them of any special activities that might be occurring (i.e., Homecoming, Senior Night, etc.)
2. Give the official a number they can call in case of an emergency or postponement due to weather.
3. Have competent workers assigned at all contests (scorers, announcers, chain crew, etc.). These people are of great assistance to the official during the contest.
4. Have a host assigned to meet the officials as they arrive. The host should do the following for the officials:
  - A) Provide a reserved parking space.
  - B) Meet officials and take them to the dressing room.
  - C) Have refreshments available for halftime and postgame.
  - D) Ask for any additional needs.
  - E) Introduce the officials to those game workers pertinent to the contest (i.e., scorer, announcer, chain gang, etc.).
  - F) Get the proper pronunciation of officials' names so they are correct when given by the public address announcer.
5. Athletic director should discuss with the officials any special events, conference rules, national anthem time, etc. that would affect the game.
6. Provide the officials with the name of the adult supervisor for that contest and where that person can be found in the event a challenging situation should occur.
7. Make officials aware of location of an athletic trainer or other first responders during the contest. Have a doctor on site when possible (especially at football contests).
8. Make sure all bench personnel are properly attired.
9. Do a check on game scoreboards and lighting systems prior to the game or contest.
10. Make sure the playing area is properly marked and meets National Federation guidelines for that contest.
11. Provide appropriate secured dressing area and hot water showering facilities.



# SCHOOL'S RESPONSIBILITY TO AN OFFICIAL DURING THE CONTEST

1. Insist coaches display good sportsmanship and are proper examples for your players and crowd.
2. Have your public address announcer or cheerleader read the IHSA sportsmanship statement and remain unbiased during contest.
3. Make sure the event supervisor understands the duties and responsibilities pertinent to that contest.
4. Make sure the playing area is maintained during halftime of each contest. For wrestling, make sure the mat is properly cleaned and washed.
5. Help with adverse weather conditions; monitor accordingly.
6. Make sure proper crowd control is visible and in place. Good administrative control can prevent difficult situations.
7. Observe the crowd during the contest and prevent any disturbances that may occur.
8. Work with the official during the game regarding crowd control.
9. Retrieve the game ball at the end of the contest.
10. Escort the officials back to the dressing room at halftime and at the conclusion of the contest.

## SCHOOL'S RESPONSIBILITY TO AN OFFICIAL AFTER THE CONTEST

1. Escort the officials safely back to the dressing room and parking lot.
2. Do not allow unauthorized persons in the dressing room after the game. This includes coaches.
3. Have refreshments available for the officials after the contest.
4. Be sure to thank the officials for their time and effort, regardless of the outcome of the game.
5. Make sure arrangements for paying the officials have been completed. It is preferable to pay the official the day of contest.
6. Ensure that officials are not confronted by anyone after the contest.





## 2015 Sectional Track Meeting Agenda

**The Officials assigned to your Sectional Track Meet are posted on each respective Sectional Host's School's Center Web Site. Please log in using your password to obtain this information.**

**6:45 PM:** Coaches must immediately report any scratches and changes to their original entry list. This must be done at this time (prior to seeing the heat sheets for this meet)! Only individual times, relay times, and names in individual events may be changed. Individual entries left blank at the time of the on-line entry deadline, may not be filled in now. Relay team members may not be changed at any time, for any reason. No substitutions are allowed following the seed meeting except as allowed in T&C item V-C-15.

**7:00 PM Role Call:** Pass out a document to all head coaches showing all entries. All coaches should make a final check of the official entries made by all coaches.

Explain to the coaches that they have the right/responsibility to challenge times and distances for any entry made in this meet and that coaches must be able to verify the times and distances they have entered if respectfully asked to do so (T&C Item V-C-5).

**IMPORTANT:** Remember that only sectional meets using FAT systems will be allowed to qualify individuals based on times. No competitor achieving the IHSA qualifying standard based on a manual time will be allowed to advance to the state finals (unless he/she finishes 1st or 2nd). If any timing system other than an FAT system is used to time the sectional meet, then only the 1st and 2nd place finishers will advance to the state final meet. If an FAT timing system fails during the meet for any event, the meet manager must contact Ron McGraw to discuss the situation and ask if it will be allowed to convert manual times recorded at the finish line by officials assigned as back up timers to FAT times to qualify competitors for the state finals. Qualifying for field events will remain as it has been in the past (1st and 2nd place qualify as well as those competitors meeting the state qualifying standard).

As per the terms and conditions (T&C Item V-C-1), schools are not required to attend the seed meeting. Please seed all teams that have entries included in the IHSA electronic folder. All properly entered athletes must be seeded fairly, regardless of whether or not his/her coach is in attendance.

Please refer to the new online Seeding Procedures document located on the IHSA T&F page for specific seeding instructions.

### 7:15 PM:

- A. Following the opportunity to address any challenges, use the original entries now edited with the allowable changes made as coaches entered the meeting room, seed the meet. Refer to the Managers Manual and the IHSA T&F Seeding Procedures document located on the IHSA T&F page for help relative to seeding procedures. Distribute the final heat sheets to head coaches or each school's official representative.
- B. Meet Manager should introduce themselves, the meet referee and starter and allow the officials to address the coaches concerning the following:
  1. Uniforms
    - a. All competitors must wear school issued uniforms.
    - b. All undergarments for members of any relay team must be similar, (not identical).
    - c. All shirts will be tucked in at the State Series Meets.
    - d. Watches will not be worn by competitors during competition.
  2. Checking In
    - a. You must check in to each event that you are entered. If in two events, you must check in to both events. If you leave one event for another, you must check out with one judge and check in with the other. You must tell the judge you are leaving and when you will be back (it is suggested that no athlete be away for more than 10 to 15 minutes). No event will be held up because an athlete failed to return to that event.
    - b. Athletes will report when flights are called. When a running event is called all heats of that event must report to the Clerk of the Course. All four runners should report when their relay is called. Contestants that fail to report prior to the Clerk of the Course closing the entries in running events, or after the judge starts competition in the field events shall not be allowed to participate in that event.
    - c. Running events take preference over field events.
  3. Disqualification: The referee shall notify the athlete and/or coach relative to any disqualifications.
  4. Coaches Box – Pole Vault: Where will it be located?
  5. Restricted areas – Coaches and non-participating athletes
    - a. Where will coaches, athletes and spectators not be allowed? (Track and all infield?)
    - b. Where team uniform removal is prohibited.
    - c. Where no electronic communication devices are allowed. This rule applies not just to the use of such devices, but to the possession as well.

6. Markings
    - a. On the track (Make sure you have marked a 1 meter step start line)
    - b. On the runways
    - c. On the apron
  7. Appeals
    - a. Refer to rule 3-5-4 for the list of situations that cannot be appealed.
    - b. If you appeal you must state the rule, and what you are appealing in writing. All appeals go to the referee. The Jury of Appeals may not set aside any rule in considering any appeal.
  8. When a field event is over no more practice is allowed. Everyone must stay off of the jumping pits, landing areas and throwing circles. There will be no warm up without supervision (coach or the adult supervising the event).
  9. Relays: Handoffs – Make sure both runners stay in their lanes for the 4x100 and the 4x200. After handing off, stand still or jog straight ahead. Listen to the instructions of the Starter and/or the Clerk 4x800, 4x400.
  10. Inspection and Weigh in of implements (it is recommended that each site have the gauge used to measure the dimensions of the shot and discus)
    - a. Shot Put
    - b. Discus
    - c. Pole Vault
    - d. Make sure shot and discus are clean for the weigh in and are of legal weight and legal dimensions. Many of the same implements used at sectional meets are impounded at the state finals for not passing the implement inspection at the state finals.
  11. Captains and Coaches meeting will be held after the scratch meeting.
- C. MEET MANAGER Address the following:
1. Time schedule
  2. Inclement weather- Remember: When thunder roars, go indoors!
  3. Trainer availability (if any)
  4. IHSA sectional shirts
  5. Parking – cars – busses
  6. Pole Vault weigh in and pole check
  7. Coaches Instructions to athletes – on and off the field
  8. Ask for volunteer officials from each school to help fill in where needed. All schools entered in the IHSA T&F State Series are required to provide one qualified volunteer when asked to do so by the meet host (T&CV-C-18). The head coach will serve in place of the volunteer provided by his/her school if the volunteer fails to appear at the sectional meet for his/her assigned duty.
  9. Elect games committee (Jury of Appeals) and IHSA sectional Representative.
  10. **Remind scorer of the following:**
    - a. **Email a set of complete results to [rmcgraw@ihsa.org](mailto:rmcgraw@ihsa.org).**
    - b. **Upload.pdf file of the complete results**
- 7:55 PM:** Discuss concerns for the IHSA representative to present to the track advisory committee in writing.
- 8:15 PM:** Pass out the completed schedule with heat sheets.

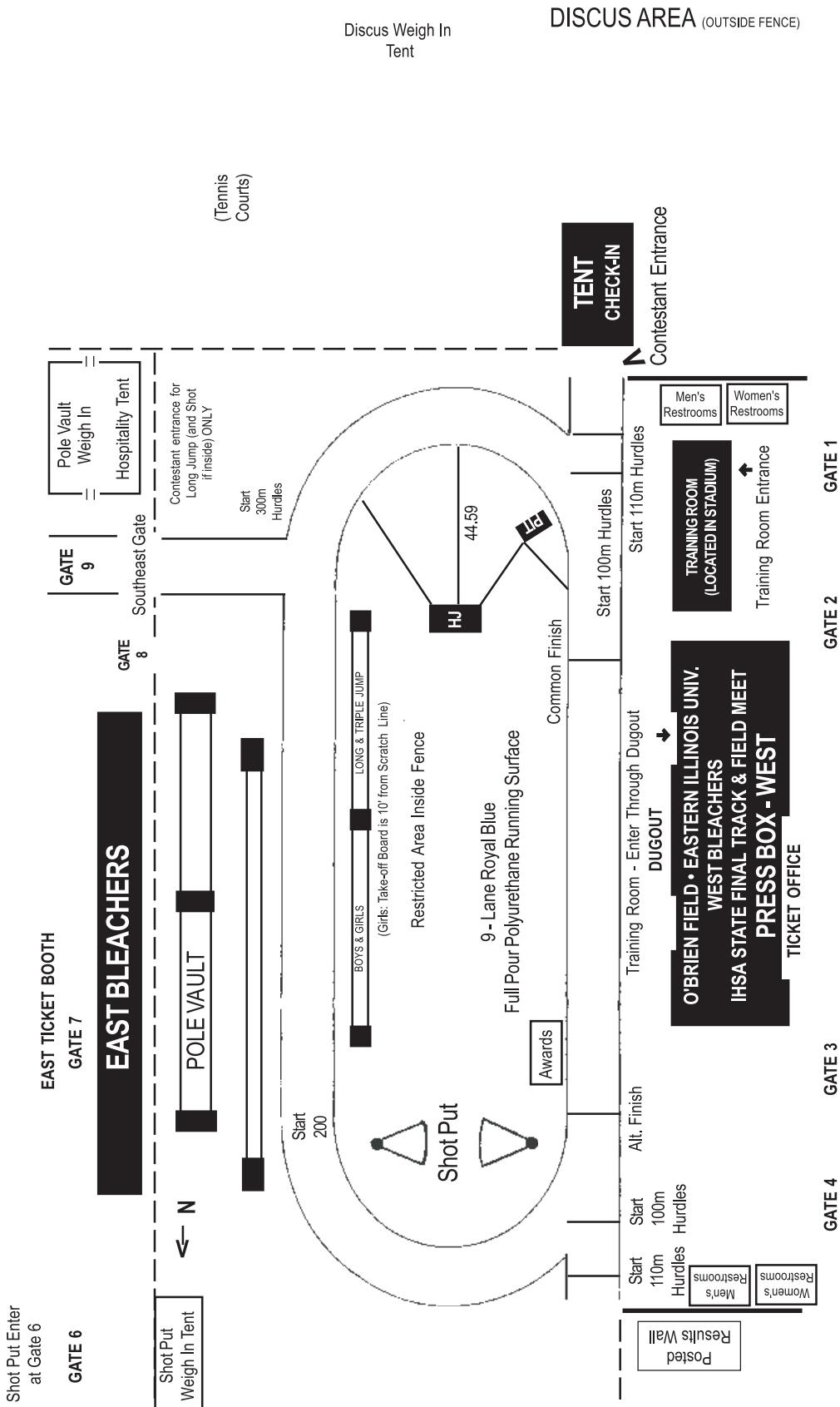



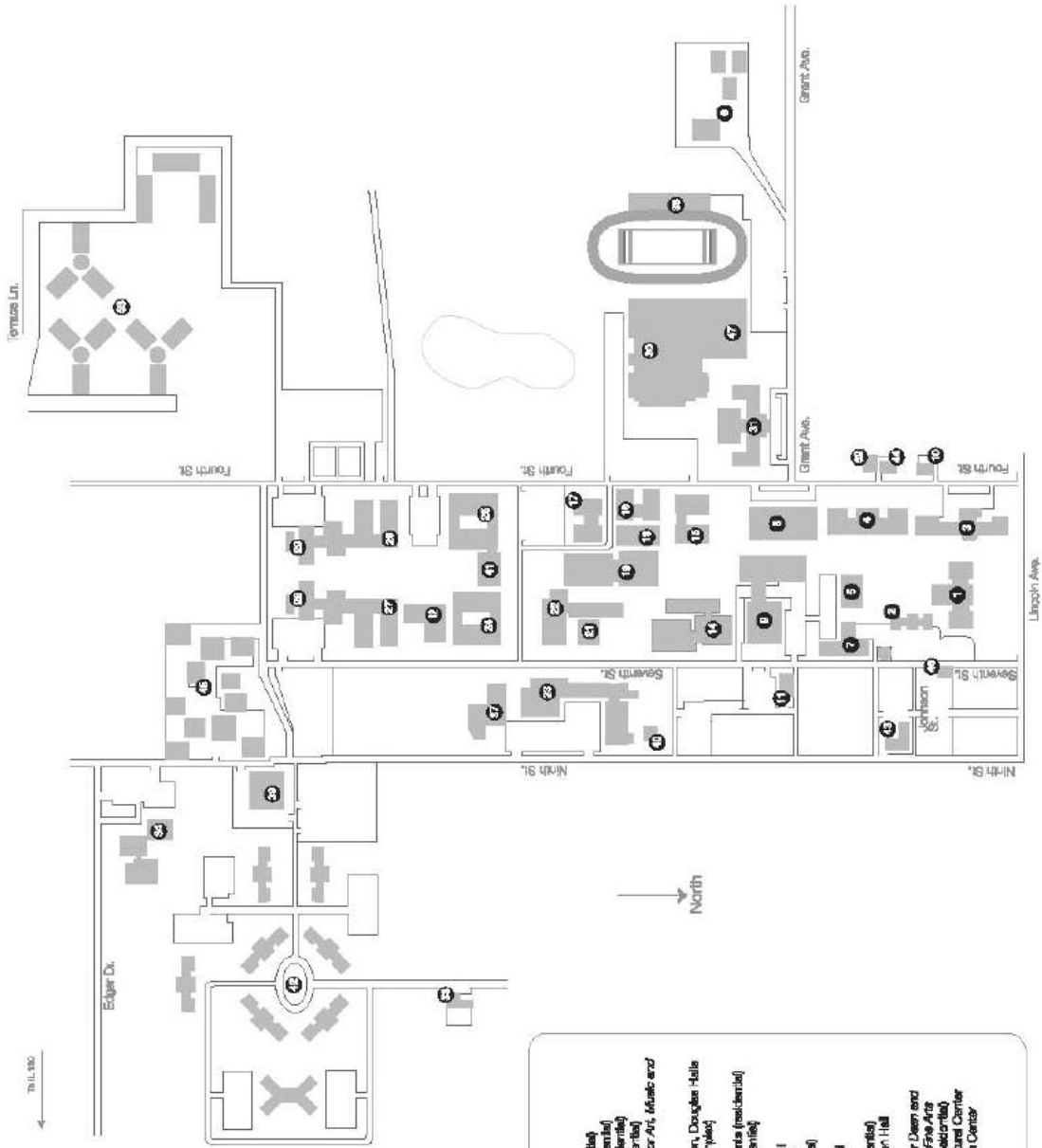

600 Lincoln Avenue, Charleston, IL 61923-5099

**building legend**

- 1. Old Main
- 2. Blair Hall
- 3. Pemberton Hall (residential)
- 4. Physical Sciences Building
- 5. Student Services Building
- 6. Physical Plant Services Building
- 7. Power Plant
- 8. Nichols Gym
- 9. University Union
- 10. Booth House
- 11. University Police Department
- 12. Human Services Building
- 14. Fine Arts Center (under renovation)
- 15. Temporary Art Dept. West, 700 Lincoln Avenue
- 16. Art Dept. East, 700 Lincoln Avenue
- 17. Adams Art Dept. West, 700 Lincoln Avenue
- 18. Adams Art Dept. East, 700 Lincoln Avenue
- 19. Adams Art Dept. West, 700 Lincoln Avenue
- 20. Adams Art Dept. East, 700 Lincoln Avenue
- 21. Adams Art Dept. West, 700 Lincoln Avenue
- 22. Adams Art Dept. East, 700 Lincoln Avenue
- 23. Adams Art Dept. West, 700 Lincoln Avenue
- 24. Adams Art Dept. East, 700 Lincoln Avenue
- 25. Adams Art Dept. West, 700 Lincoln Avenue
- 26. Adams Art Dept. East, 700 Lincoln Avenue
- 27. Adams Art Dept. West, 700 Lincoln Avenue
- 28. Adams Art Dept. East, 700 Lincoln Avenue
- 29. Adams Art Dept. West, 700 Lincoln Avenue
- 30. Adams Art Dept. East, 700 Lincoln Avenue
- 31. Adams Art Dept. West, 700 Lincoln Avenue
- 32. Adams Art Dept. East, 700 Lincoln Avenue
- 33. Adams Art Dept. West, 700 Lincoln Avenue
- 34. Adams Art Dept. East, 700 Lincoln Avenue
- 35. Adams Art Dept. West, 700 Lincoln Avenue
- 36. Adams Art Dept. East, 700 Lincoln Avenue
- 37. Adams Art Dept. West, 700 Lincoln Avenue
- 38. Adams Art Dept. East, 700 Lincoln Avenue
- 39. Adams Art Dept. West, 700 Lincoln Avenue
- 40. Adams Art Dept. East, 700 Lincoln Avenue
- 41. Adams Art Dept. West, 700 Lincoln Avenue
- 42. Adams Art Dept. East, 700 Lincoln Avenue
- 43. Adams Art Dept. West, 700 Lincoln Avenue
- 44. Adams Art Dept. East, 700 Lincoln Avenue
- 45. Adams Art Dept. West, 700 Lincoln Avenue
- 46. Adams Art Dept. East, 700 Lincoln Avenue
- 47. Adams Art Dept. West, 700 Lincoln Avenue



# Pole Vault Entry Card



(Type or Print)

Date: \_\_\_\_\_

Meet Location: \_\_\_\_\_

(School Name)

(City)

First Name	Last Name	Year in School	Current Weight of Vaulter

The National Federation is requiring that all coaches verify their Pole Vaulter(s) are competing at a legal weight relative to the pole they are using for competition. Your signature indicates your athlete(s) are in compliance.

Coach's Name: \_\_\_\_\_

Coach's Signature: \_\_\_\_\_

## 2015 IHSA Track & Field Official Competitor Scratch Verification Report

This report must be turned into the gatekeeper at the rear of the Clerks tent to report any scratches from any event. This is the only acceptable form to report scratches. Scratches on any other form will result in the coach being called to the tent. Additional forms can be acquired through the gatekeeper at the rear of the Clerks tents.

Class (circle one):      1A      2A      3A

Competitor Number	Competitors Name	Event	Heat/Flight

School (Name, City) \_\_\_\_\_

Head Coach Signature \_\_\_\_\_

Head Coach (printed) \_\_\_\_\_

Head Coach (cell phone) \_\_\_\_\_

## 2014-2015 IHSA Request To Purchase Additional/Replacement State Series Awards

- 1.) To ensure an accurate order of replacement awards, please complete the form below.
- 2.) Please fax this completed form to Cheryl Lowery @ 309-663-7479.
- 3.) An invoice will be emailed to you. The awards company will not process duplicate orders without an invoice from IHSA and payment.
- 4.) Mail payment and invoice to A & M Products.

◆ **This form is to be used only, if your school is purchasing duplicate awards for the following reason (check one):**

Team Roster exceeds the number of allowed medallions per the T&C's

Coop School  
 Dual Campus  
 Lost  
 Broken

**Sport or Activity:** \_\_\_\_\_ **Year:** \_\_\_\_\_ **Qty.:** \_\_\_\_\_ **Place:** \_\_\_\_\_

Classification		
<input type="checkbox"/> 1A	<input type="checkbox"/> 5A	<input type="checkbox"/> Class A
<input type="checkbox"/> 2A	<input type="checkbox"/> 6A	<input type="checkbox"/> Class AA
<input type="checkbox"/> 3A	<input type="checkbox"/> 7A	
<input type="checkbox"/> 4A	<input type="checkbox"/> 8A	

<b>Gender:</b>
<input type="checkbox"/> Girls <input type="checkbox"/> Boys

<b>Level of Competition:</b>
<input type="checkbox"/> Regional <input type="checkbox"/> Sectional <input type="checkbox"/> Super-Sectional <input type="checkbox"/> State

<b>Type of Award:</b>	
<input type="checkbox"/> Team Plaque	<input type="checkbox"/> Gold State 3rd/4th Place-top figure (#1)
<input type="checkbox"/> Team Trophy	<input type="checkbox"/> State 3 <sup>rd</sup> /4 <sup>th</sup> Place Gold-side figure (#2)
<input type="checkbox"/> Medal/Medallion	<input type="checkbox"/> Gold Girls Soccer-side figure 3 <sup>rd</sup> /4 <sup>th</sup> (#3)
<b>Replacement Trophy Parts (check below):</b>	
<input type="checkbox"/> Gold State Champion-top figure (#1)	<input type="checkbox"/> Badminton Gold shuttlecock and/or riser
<input type="checkbox"/> Gold State Champion-side figure (#1)	<input type="checkbox"/> Replacement Trophy Plate w/lasering
<input type="checkbox"/> Gold State Runner-up-top figure (#1)	<input type="checkbox"/> Bat, Tennis, Golf Club Replacement
<input type="checkbox"/> Gold State Runner-up-side figure (#1)	<input type="checkbox"/> Replacement Plate SF Trophy w/o lasering

**Ind. Event Medals** (indicate Event name): \_\_\_\_\_  
 (ie: Pole Vault, Long Jump, Diving, 100-yd. Butterfly, Single, Doubles, 102lb., Speech: IE, etc.)

<b>Name:</b>
<b>Email Address:</b>
<b>School:</b>
<b>Address:</b>
<b>City, ZIP Code:</b>
<b>Phone Number:</b>
<b>Fax Number:</b>

Macintosh  
 HD:Users:jackieiverson:Desktop:\*\*\*Ma  
 nual Files:Awards forms:School  
 Awards Form.doc



## 2014-2015 IHSA Request To Purchase Additional/Replacement State Series Awards

- ◆ **Tournament Managers/Hosts** who need to request duplicate awards due to ties at their tournament/meet must complete the form in the Online Manual for Managers and send it directly to the awards company– **Do Not Use the form above.**
- ◆ **Trophy Letters:** Schools who need replacement letters for trophies, please contact A & M Products direct at 815-875-2667.

### Extra Medal Pricing for Schools:

<u>Qty:</u>	<u>Finish</u>	<u>State Medallion</u>	<u>Reg./Sect Medal</u>	<u>Shipping</u>
1 – 5	Goldtone (1 <sup>st</sup> )	\$4.45	\$3.95	\$6.50
	Nickel Silver (2 <sup>nd</sup> )	\$4.95	\$4.45	
	Bronze (3 <sup>rd</sup> )	\$4.60	\$4.15	
6 – 12	Goldtone (1 <sup>st</sup> )	\$4.20	\$3.70	\$7.00
	Nickel Silver (2 <sup>nd</sup> )	\$4.70	\$4.20	
	Bronze (3 <sup>rd</sup> )	\$4.35	\$3.85	
13 – 24	Goldtone (1 <sup>st</sup> )	\$3.95	\$3.45	\$7.50
	Nickel Silver (2 <sup>nd</sup> )	\$4.45	\$3.95	
	Bronze (3 <sup>rd</sup> )	\$4.10	\$3.65	
25 or more	Goldtone (1 <sup>st</sup> )	\$3.70	\$3.20	\$8.00
	Nickel Silver (2 <sup>nd</sup> )	\$4.20	\$3.70	
	Bronze (3 <sup>rd</sup> )	\$3.85	\$3.40	

### Extra Plaque/Trophy Pricing for Schools (Shipping included):

Regional Champion Plaque	\$50.00
Sectional and Super-Sectional Champion Plaque	\$66.00
Third/Fourth place trophy	\$269.00
Champion/Runner-Up	\$297.00

### Gold top figure Replacement Pricing (\$10.00 shipping per figure)

**(\$61.00 for oxidized bronze finish pre 2008-09 school year, if available)**

Gold State Champion-top figure (#1)	\$47.00
Gold State Champion-side figure (#1)	\$47.00
Gold State Runner-up-top figure (#1)	\$47.00
Gold State Runner-up-side figure (#1)	\$47.00
Gold State 3rd/4th Place-top figure (#1)	\$47.00

### Gold side figures and plate replacement pricing

**(\$40.00 for oxidized bronze finish pre 2008-09 school year, if available)**

State 3 <sup>rd</sup> /4 <sup>th</sup> Place Gold-side figure (#2)	\$32.00, plus \$10.00 shipping
Girls Soccer – Gold-side figure 3 <sup>rd</sup> /4 <sup>th</sup> Place (#3)	\$30.00, plus \$10.00 shipping
Music Lyre – Gold-side figure 3 <sup>rd</sup> Place (#3)	\$24.50, plus \$10.00 shipping
Badminton Gold shuttlecock and/or riser	\$30.00, plus \$10.00 shipping
Repl. Trophy Plate w/lasering	\$30.00, plus \$10.00 shipping
Repl. Black Plate for SF Trophy w/o lasering	\$12.00, includes shipping
Bat, Tennis, Golf Club Replacement for All Figurine	\$16.00, includes shipping

Orders will be **processed upon Receipt of Full Payment.** Please allow three (3) weeks for delivery. Thank you.