

# IHSA STATE INDIVIDUAL 1966

**Wgt Class  
95 lbs**

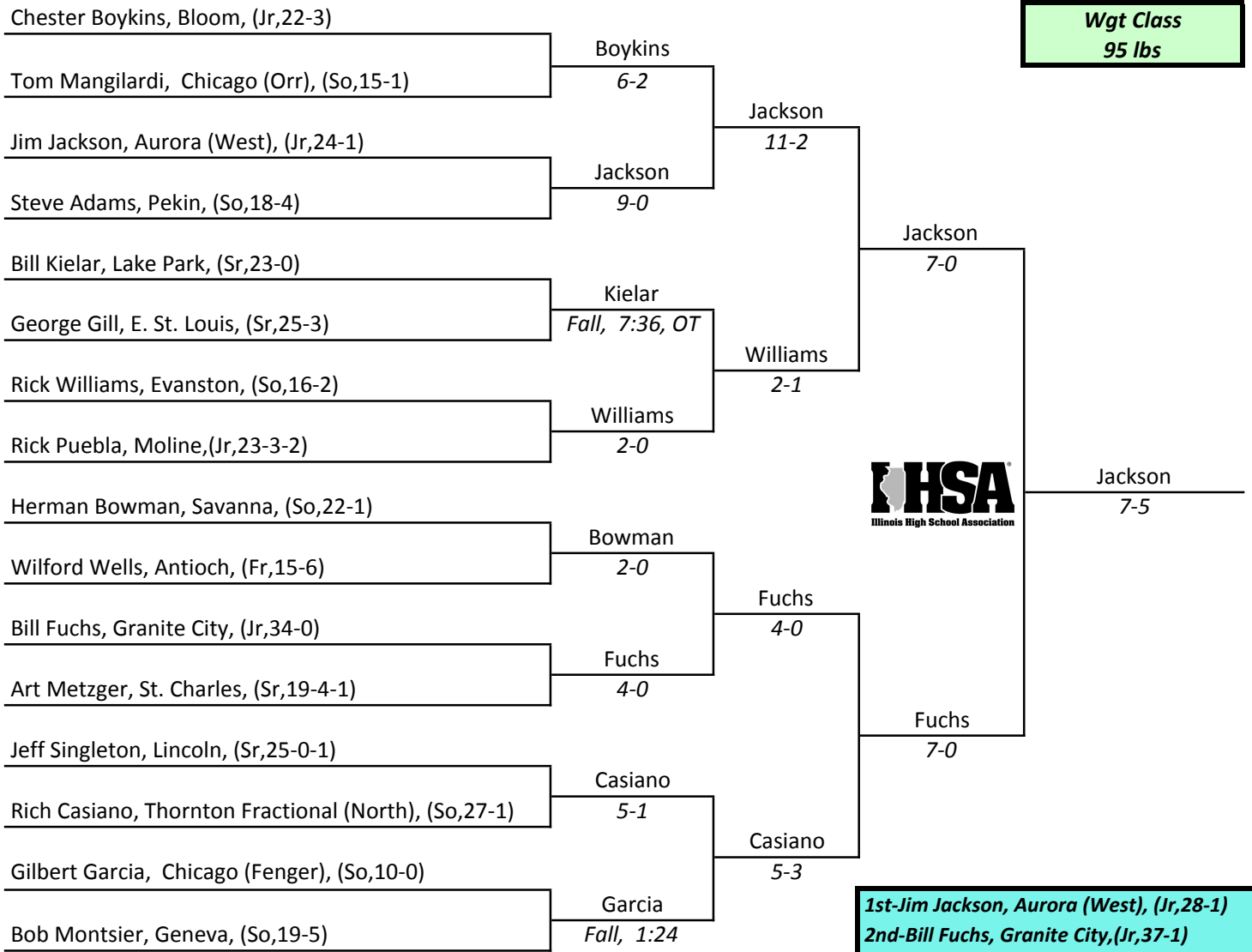

**1st-Jim Jackson, Aurora (West), (Jr,28-1)**  
**2nd-Bill Fuchs, Granite City,(Jr,37-1)**  
**3rd-Rich Casiano, TF North, (So,31-2)**  
**4th-Rick Williams, Evanston,(So,19-4)**

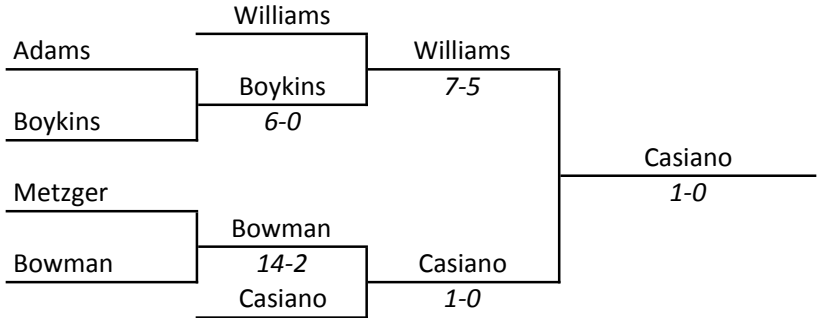

# IHSA STATE INDIVIDUAL 1966

**Wgt Class  
103 lbs**

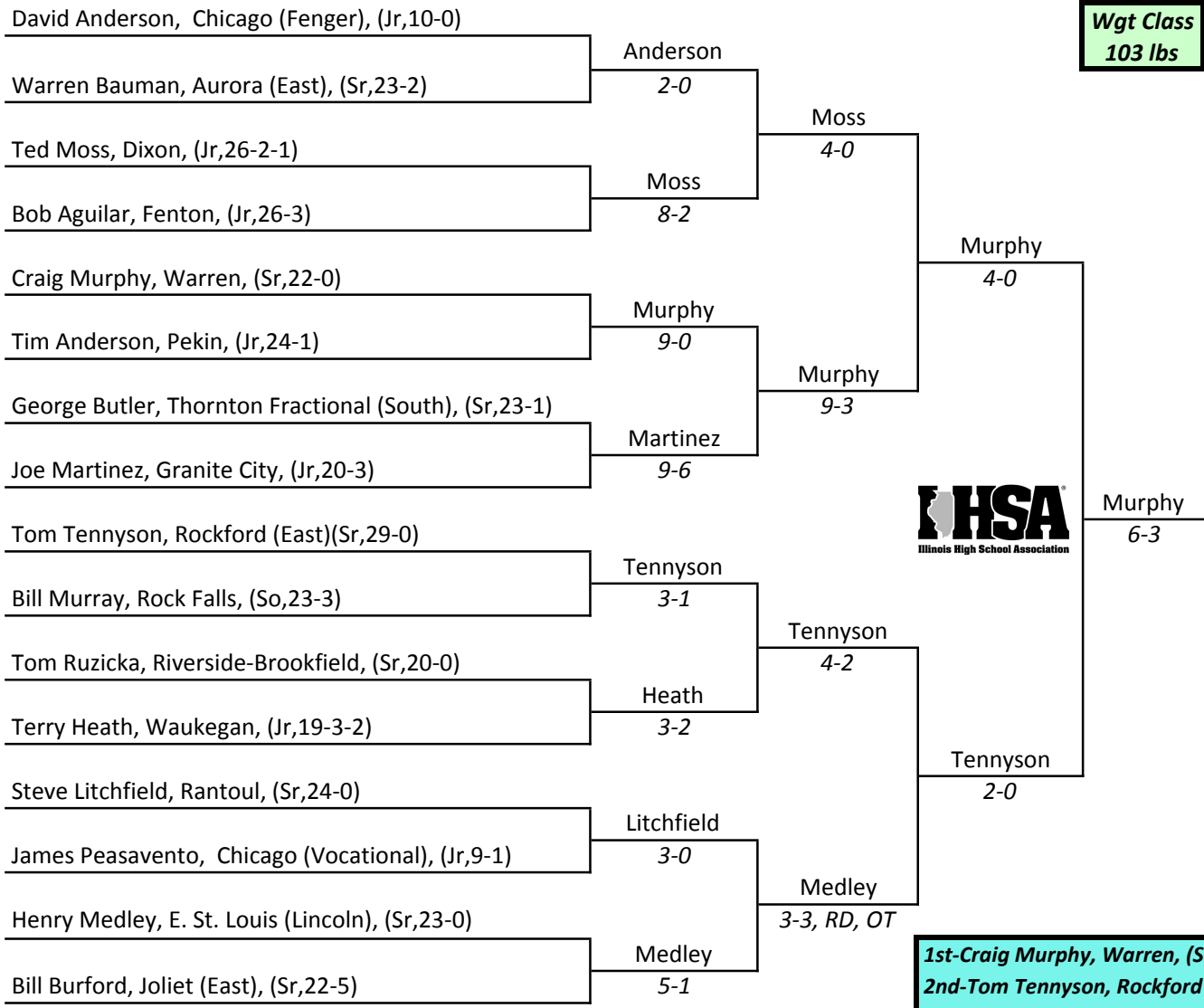

**1st-Craig Murphy, Warren, (Sr,26-0)**  
**2nd-Tom Tennyson, Rockford (East), (Sr,32-1)**  
**3rd-Joe Martinez, Granite City, (Jr,24-4)**  
**4th-Henry Medley, E.St. L. (Lincoln), (Sr,26-2)**

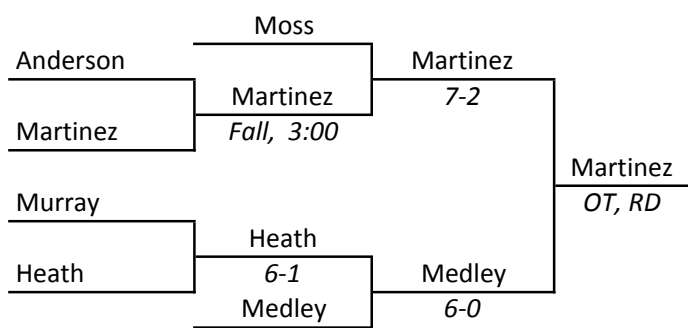

# IHSA STATE INDIVIDUAL 1966

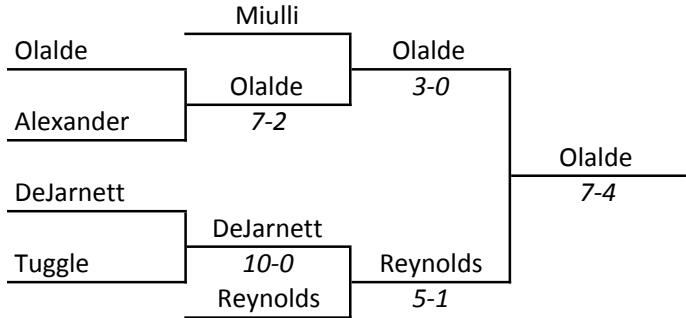
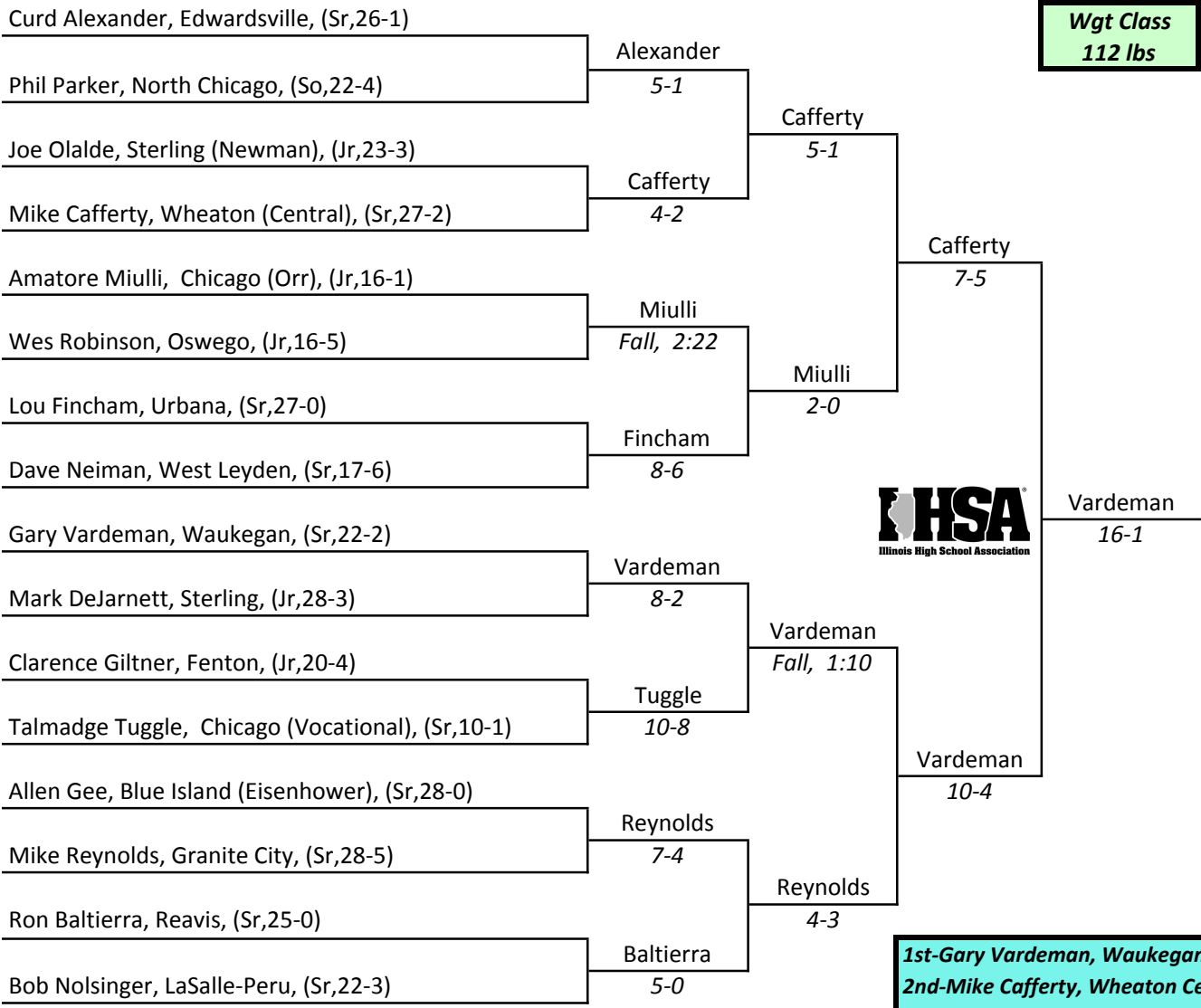

**McGaw Hall, Northwestern University, Evanston, February 25th and 26th**

# IHSA STATE INDIVIDUAL 1966

**Wgt Class  
120 lbs**

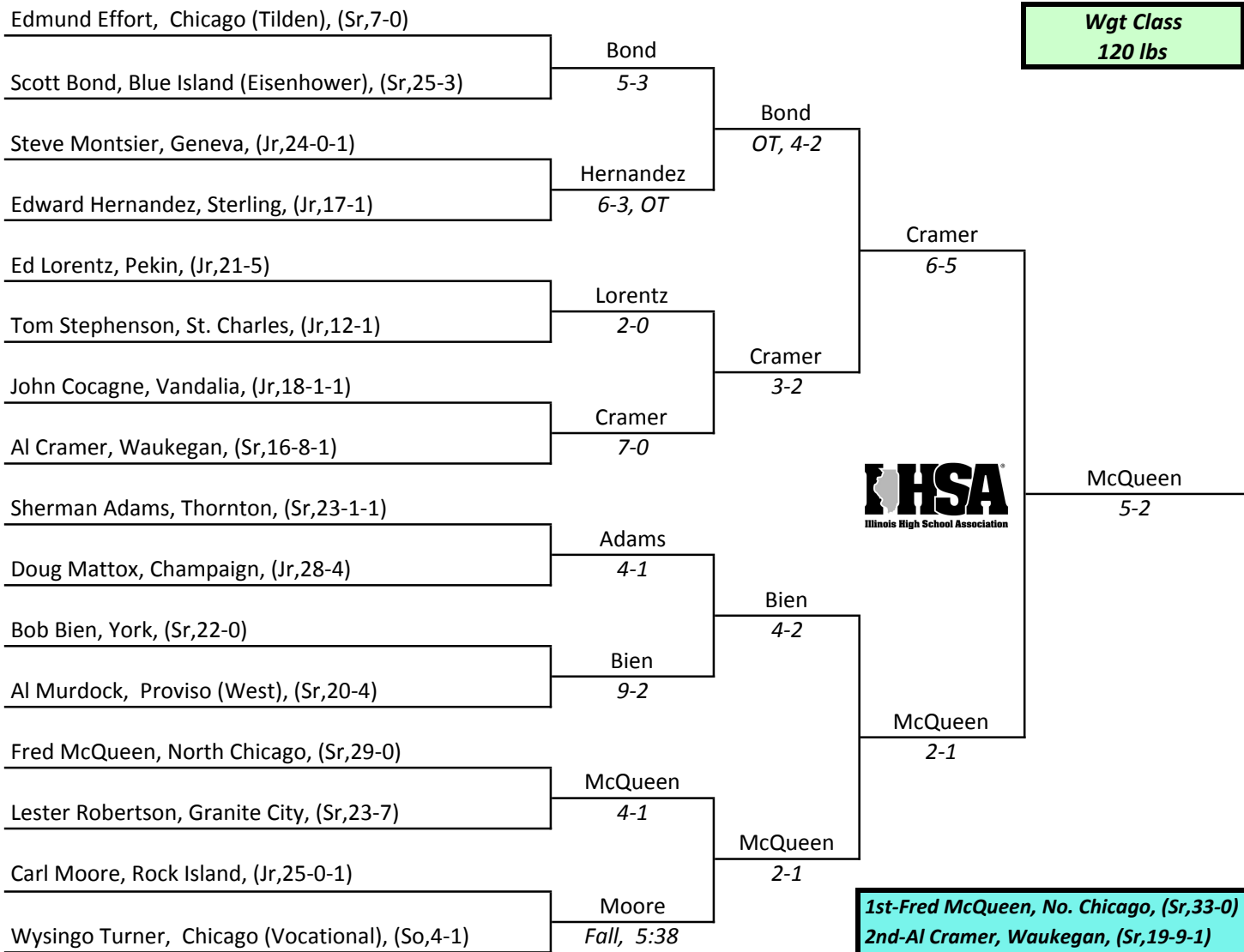

**1st-Fred McQueen, No. Chicago, (Sr,33-0)**  
**2nd-Al Cramer, Waukegan, (Sr,19-9-1)**  
**3rd-Bob Bien, York, (Sr,26-1)**  
**4th-Ed Lorentz, Pekin, (Jr,24-7)**

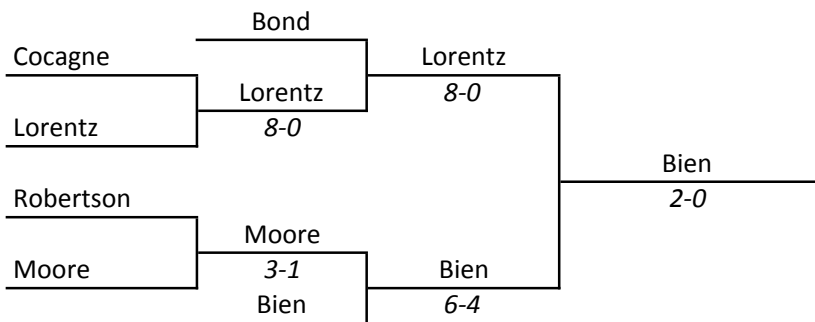

**McGaw Hall, Northwestern University, Evanston, February 25th and 26th**

# IHSA STATE INDIVIDUAL 1966

**Wgt Class  
127 lbs**

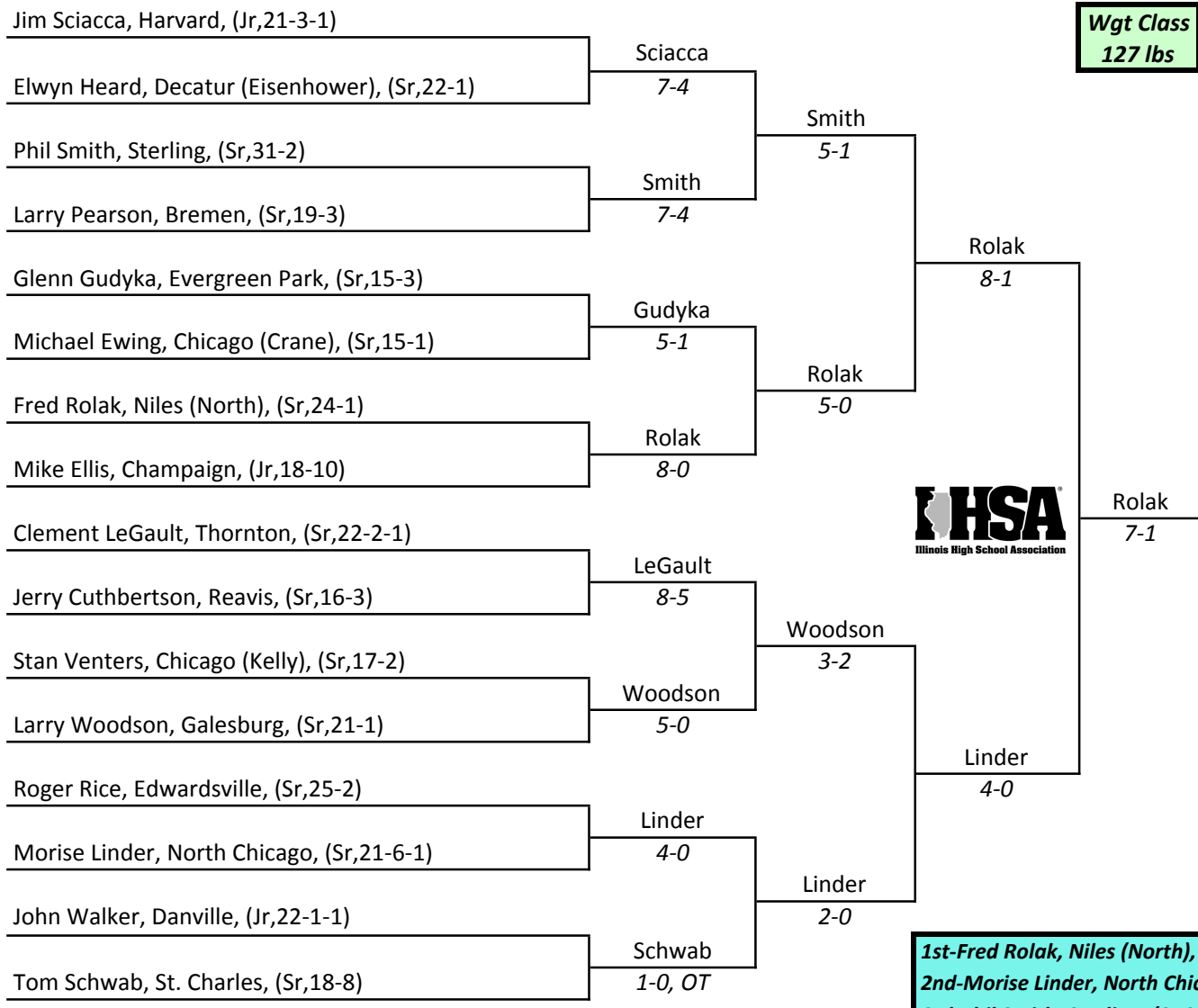

**1st-Fred Rolak, Niles (North), (Sr,28-1)**  
**2nd-Morise Linder, North Chicago, (Sr,24-7-1)**  
**3rd-Phil Smith, Sterling, (Sr,35-3)**  
**4th-Larry Woodson, Galesburg, (Sr,24-3)**

# IHSA STATE INDIVIDUAL 1966

**Wgt Class  
133 lbs**

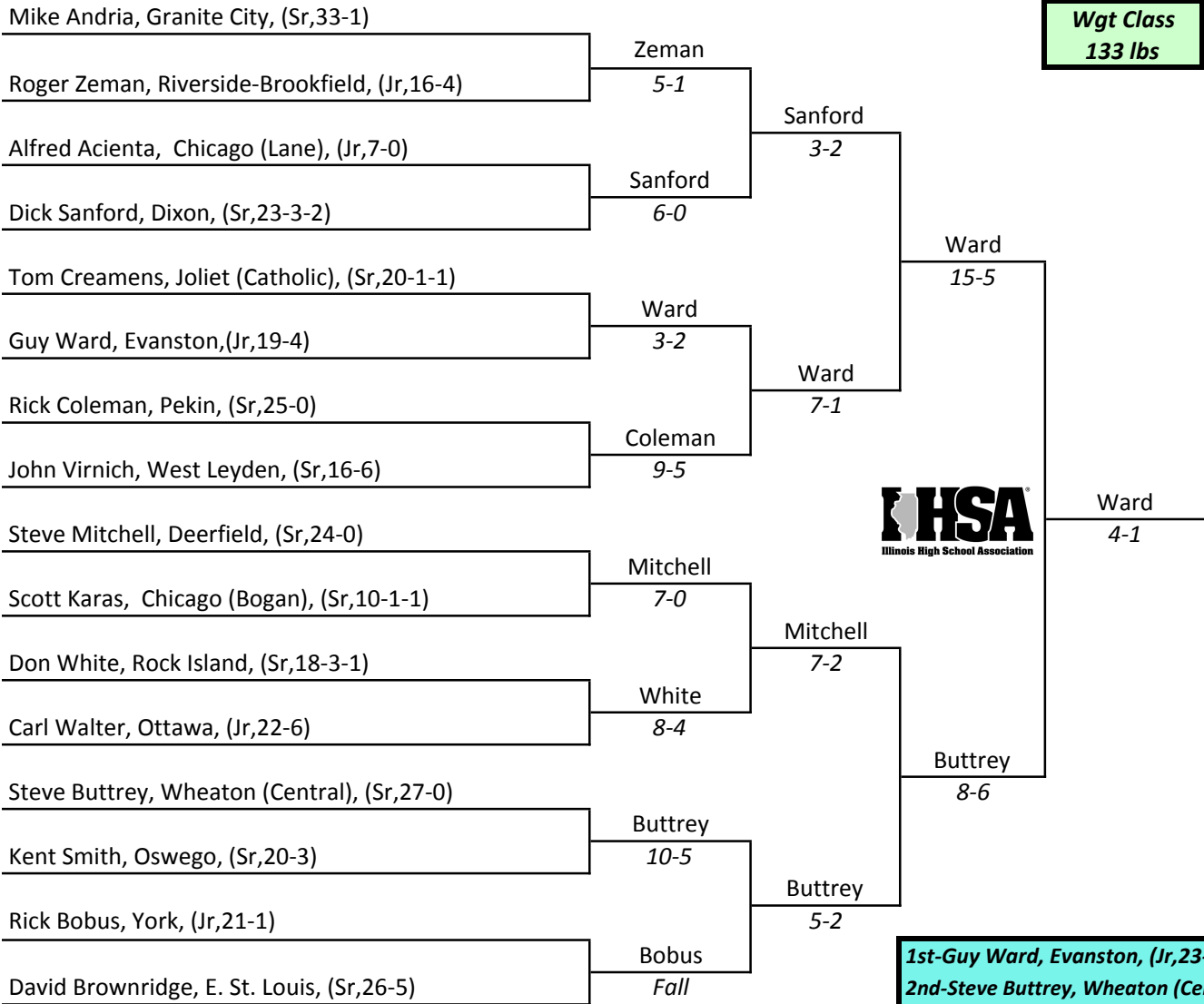

**1st-Guy Ward, Evanston, (Jr,23-4)**  
**2nd-Steve Buttrey, Wheaton (Central), (Sr,30-1)**  
**3rd-Steve Mitchell, Deerfield, (Sr,28-1)**  
**4th-Tom Creamens, Joliet (Catholic), (Sr, 22-3-1)**

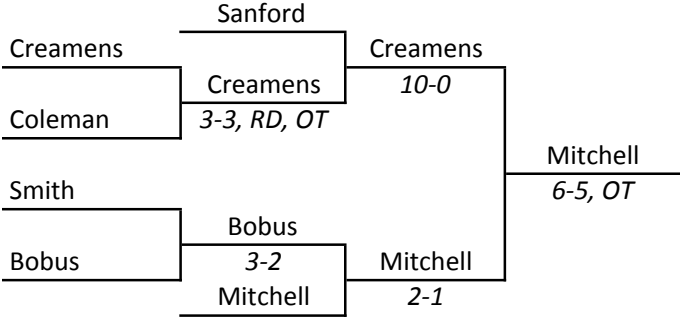

**McGaw Hall, Northwestern University, Evanston, February 25th and 26th**

# IHSA STATE INDIVIDUAL 1966

**Wgt Class**  
**138 lbs**

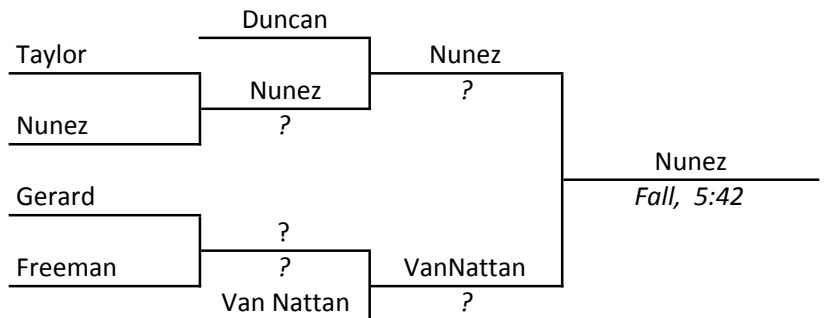

**McGaw Hall, Northwestern University, Evanston, February 25th and 26th**

# IHSA STATE INDIVIDUAL 1966

**Wgt Class**  
**145 lbs**

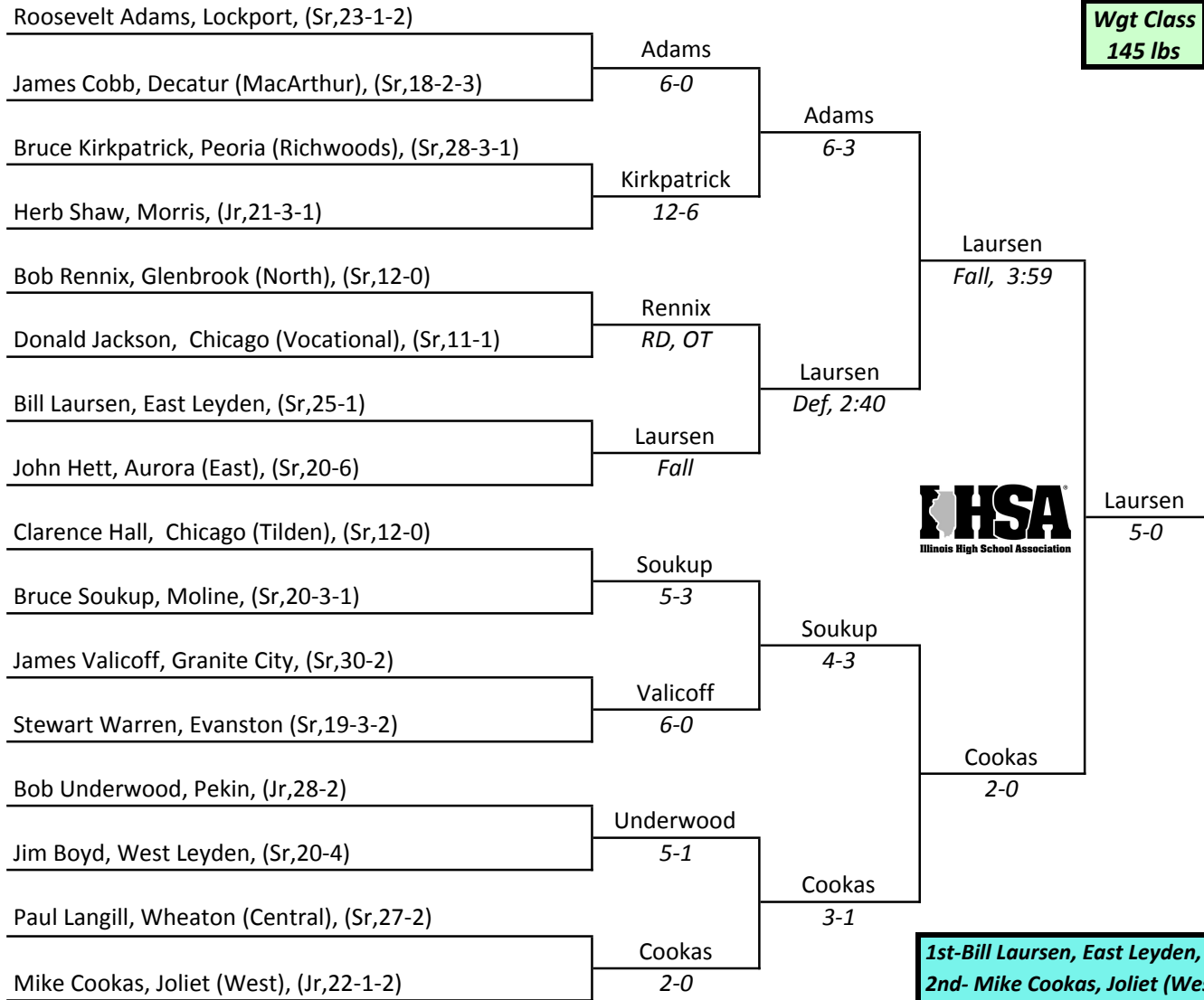

**1st-Bill Laursen, East Leyden, (29-1)**  
**2nd- Mike Cookas, Joliet (West), (Jr,25-2-2)**  
**3rd-Roosevelt Adams, Lockport, (Sr,27-2-2)**  
**4th-Paul Langill, Wheaton (Central),(Sr,29-4)**

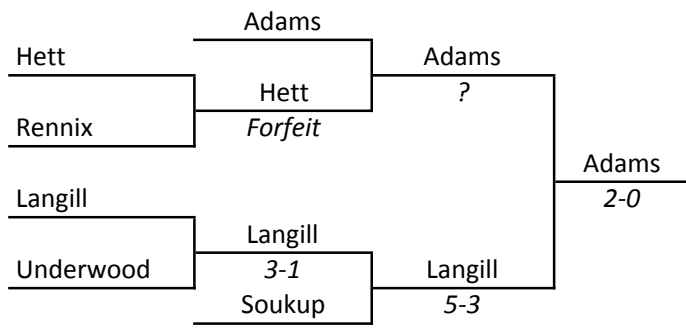

**McGaw Hall, Northwestern University, Evanston, February 25th and 26th**



# IHSA STATE INDIVIDUAL 1966

**Wgt Class  
154 lbs**

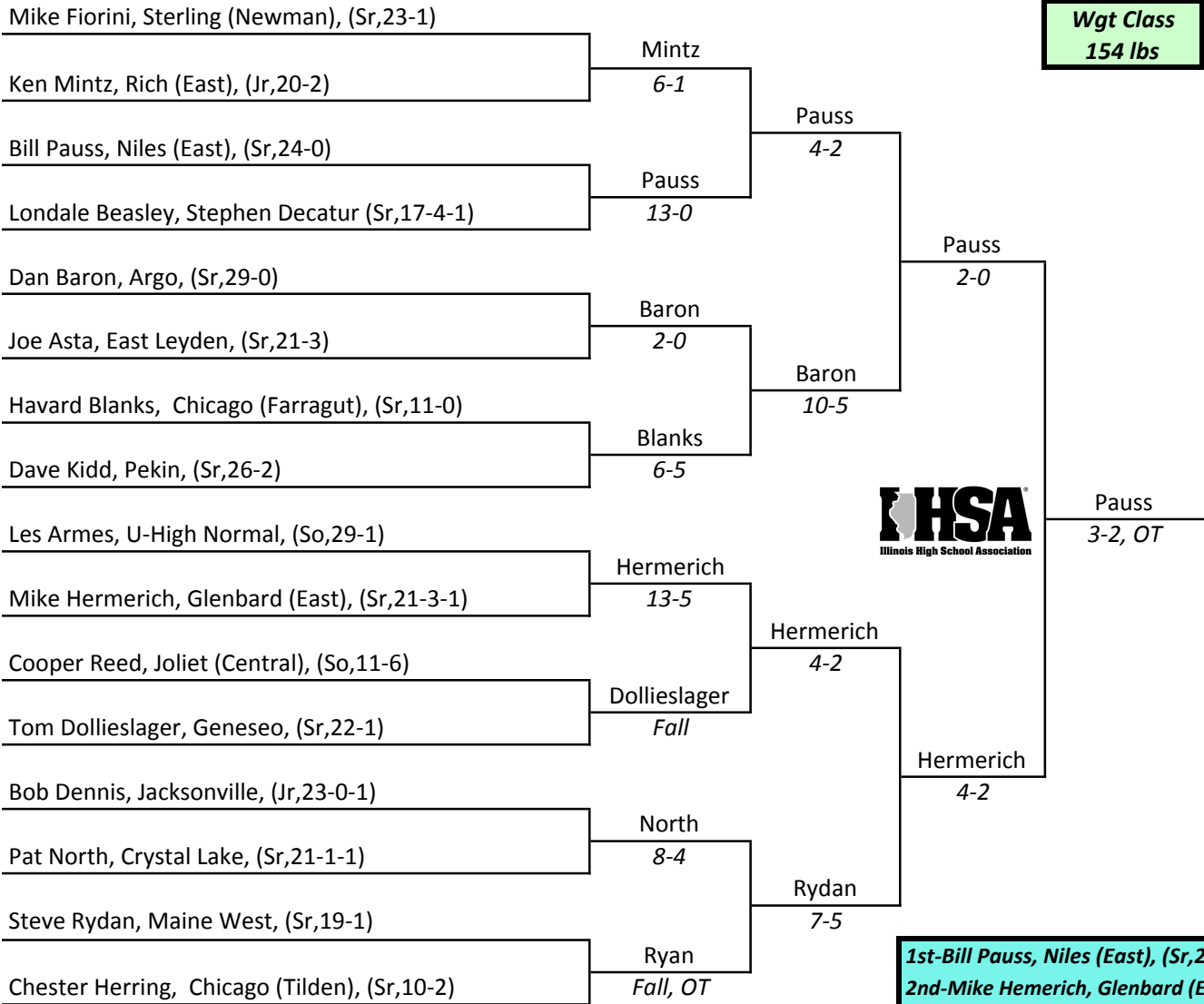

**1st-Bill Pauss, Niles (East), (Sr,28-0)**  
**2nd-Mike Hemerich, Glenbard (East), (Sr,24-4-1)**  
**3rd-Dan Baron, Argo, (Sr,33-1)**  
**4th-Les Armes, U-High Normal, (So,31-3)**

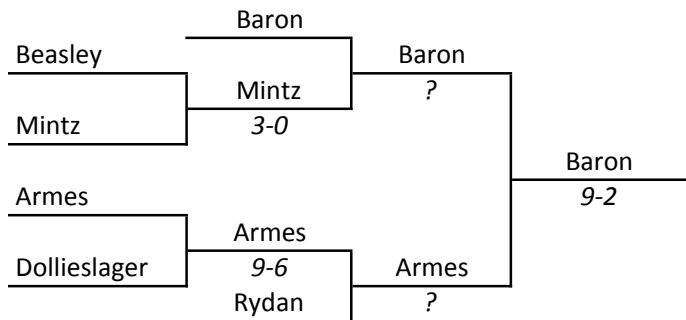

**McGaw Hall, Northwestern University, Evanston, February 25th and 26th**

# IHSA STATE INDIVIDUAL 1966

**Wgt Class  
165 lbs**

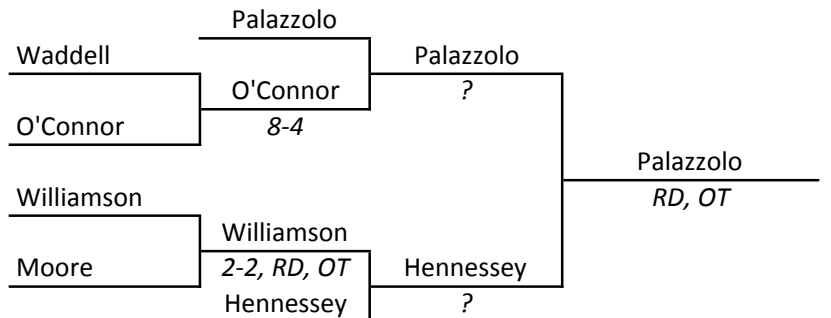
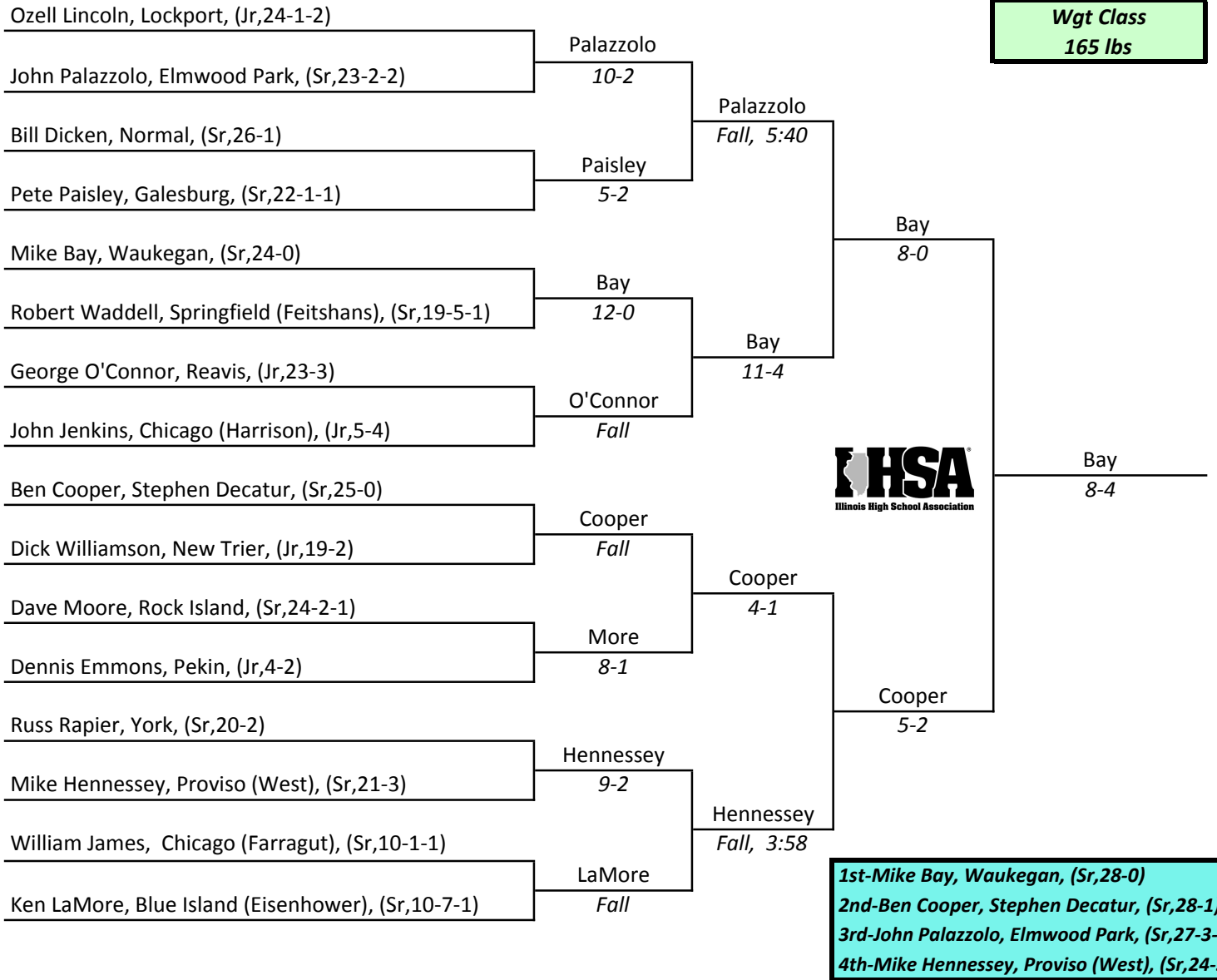

**McGaw Hall, Northwestern University, Evanston, February 25th and 26th**

# IHSA STATE INDIVIDUAL 1966

**Wgt Class**  
**180 lbs**

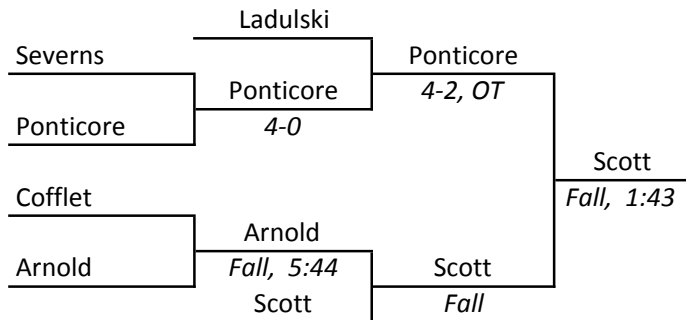
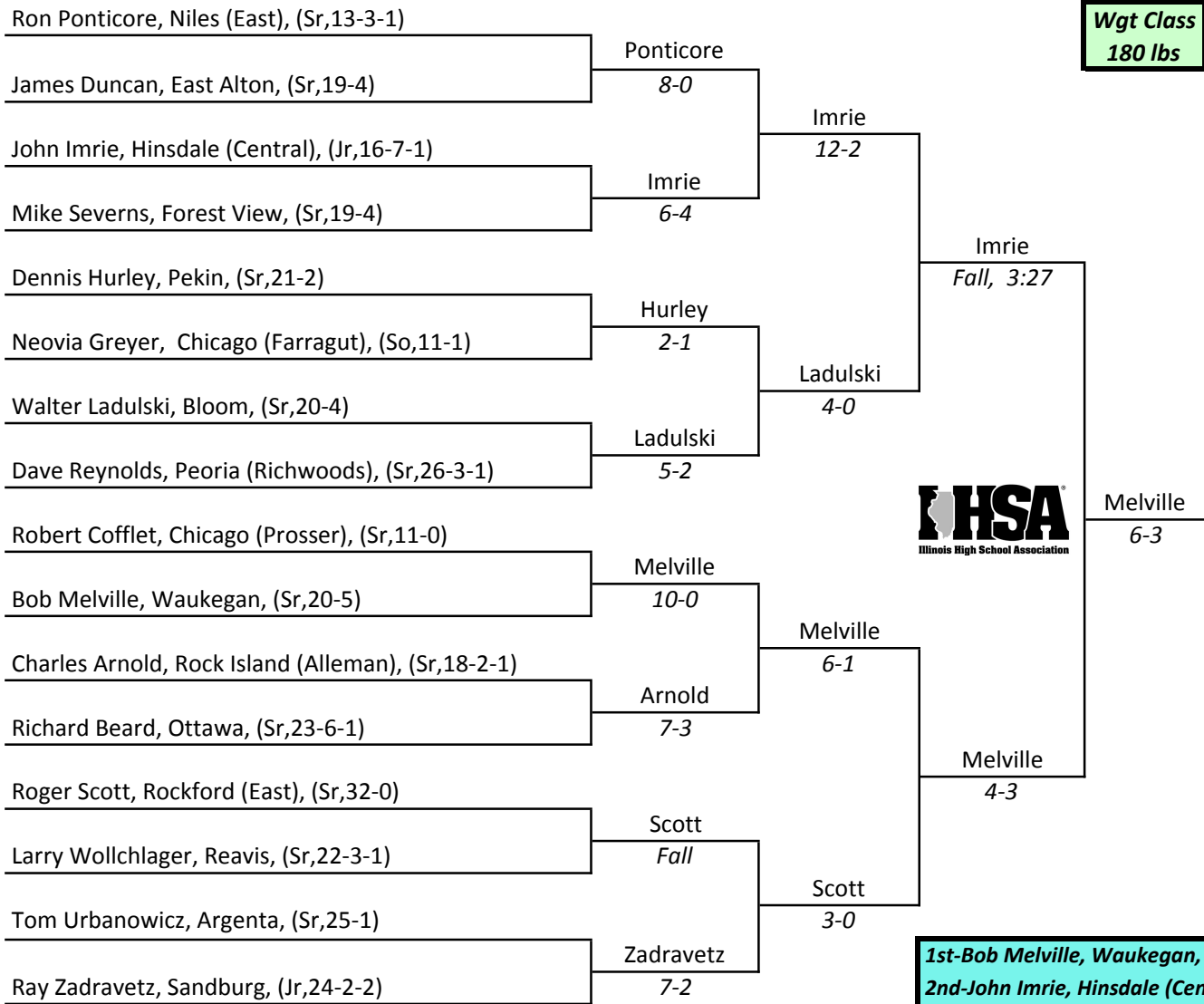

**McGaw Hall, Northwestern University, Evanston, February 25th and 26th**

# IHSA STATE INDIVIDUAL 1966

**Wgt Class  
HWT.**

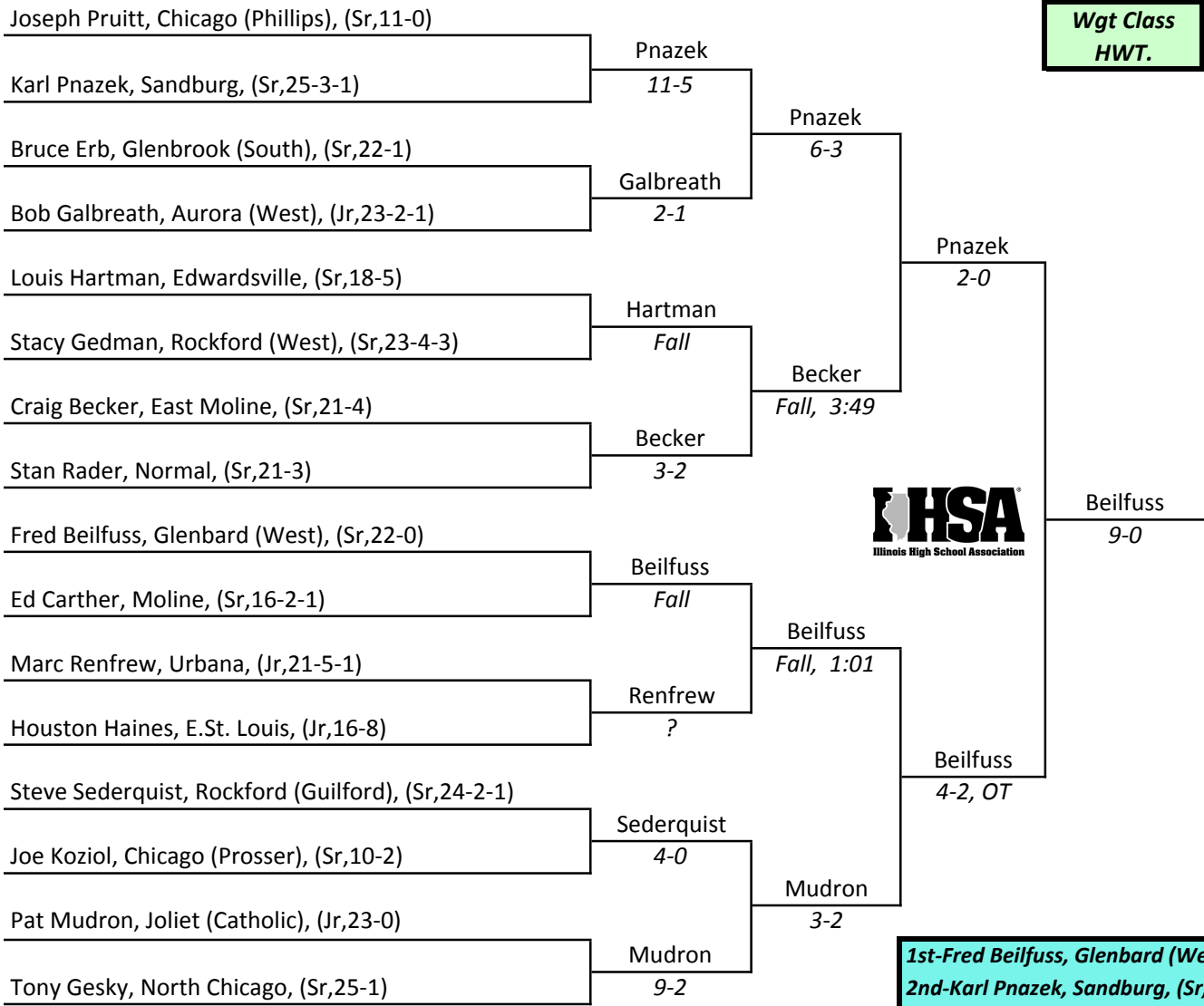

**1st-Fred Beilfuss, Glenbard (West), (Sr,26-0)**  
**2nd-Karl Pnazek, Sandburg, (Sr,28-4-1)**  
**3rd-Bob Galbreath, Aurora West, (Jr,27-3-1)**  
**4th-Par Mudron, Joliet (Catholic), (Jr,26-2)**

